



HOME OFFICE
By Multibrackets



How to Work Ef

commute to work. Thanks to ever-evolving technologies like Skype, Facetime, Slack, Zoom, Google Hangouts, authenticator apps and cloud computing - not to mention texting and email - it's no longer necessary to be in an office full-time to be a productive member of the team. In fact, many kinds of work can be done just as effectively, if not more so, from a home office. As appealing as remote work is to employees, it wouldn't be such a strong trend if employers didn't also recognize benefits from their side of the desk. Companies with work-from-anywhere policies can boost employee productivity, reduce turnover and lower organizational costs.

Whether you're working remotely one day per week (or more) or full-time—by choice or because of a health situation or weather event—it's important to ensure that you are set up to be productive. Multibrackets has many tools to support your everyday work-from-home.



HOME OFFICE

M Laptop Workstation	6 - 9
M Deskmount Slim Basic Single	10 - 13
M Deskmount Slim Basic Dual	14 - 17
M Deskmount XL	18 - 21
M VESA Gas Lift Arms	24 - 29
M VESA Deskmount Dual Vertical Wide	30 - 33
Headset Stands	34 - 35
Cable Management	36 - 37





M LAPTOP WORKSTATION SIT AND STAND WHEN WORKING FROM HOME

Own your space, move up and down while infusing your workdays with movement and ergonomics.

Introducing an easy stand

any open space into a Deskstand Workstation in a matter of seconds. Lets start enable easy height adjustment and great ergonomics with effortless touch, at home. Once you started to use this you will never go back to an old desk again, trust us - this way of work will be addictive!

This height-adjustable sit and standing desk moves quietly straight up and down as you go from sit to stand. Take your worksurface, Notebook and pivot to new heights in seconds.

This ingenious product converts any open surface to a workspace. Simply hold the handle on the side of the desk and move your M Laptop Workstation to a standing or sitting position. The worksurface holds your notebook and is ultra flexible to use with your most common accessories.



M Laptop Workstation

Article No:	7350073739141 - White 7350073739127 - Black
Height adjustment:	60-420mm
Table size:	580x320 mm
Material:	Steel, Aluminum, Plastic
Surface Finish:	Powder Coating
Colour:	White / Black
Max load:	2~10kg
Function:	Gas driven piston
Tilt angle:	+0°~-30°
Installation:	Freestanding
Measurements:	580x420x170mm
Weight:	7.2 kg
Warranty:	2 years

SIT & STAND

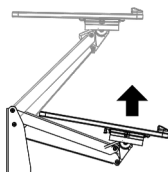

Improve your posture
Switch between standing
and sitting position

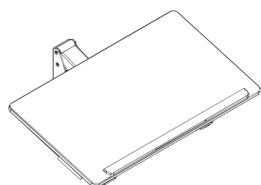

Small & compact
Designed to fit small
tables and work spaces

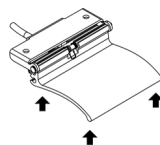

Quick elevation
Adjust the release handle to
elevate the table quickly

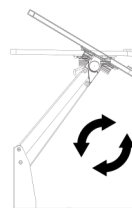

Tilttable table
Easily tilt your laptop
for better viewing

HIGHLIGHTS

- Improve your productivity by switching between sitting and standing position whilst at work
- Save your back long term as you can choose to stand up or sit down
- Provides ample of smooth vertical height adjustment
- User-friendly torque adjust holds the display weight and the rest of your work area in position with ease
- Designed for ultimate productivity in areas where less surface is available

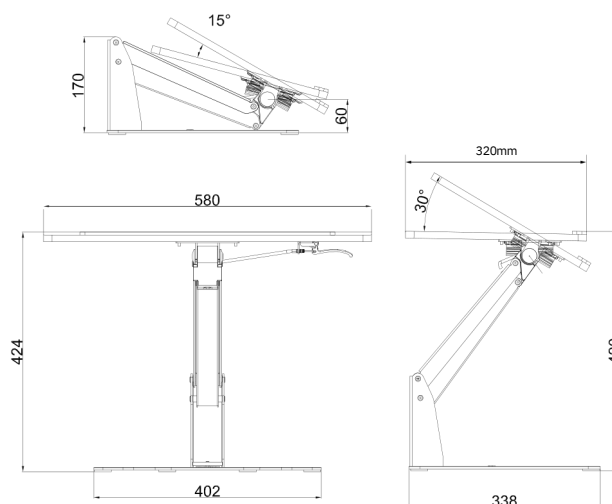





M DESKMOUNT

SLIM BASIC SINGLE A HIGH-EFFICIENCY WORKSPACE SOLUTION

Free up occupied desk space through a unique design that provides easier maneuverability and capable of moving even to fit flush against a wall.

Perfect for 17" up to some monitors, this monitor arm

angle adjustments for your optimal viewing and ergonomic posture. With a maximum weight capacity of 8kg, it can be easily mounted on most desktop surfaces with a clamp-on design that reduces installation time.

If your workspace isn't too big, Multibrackets new minimal monitor mount M Deskmount Slim Basic Single could help by freeing you up some space. The newly unveiled M Deskmount Slim Basic Single, a screen that clamps onto your desk and according to the company can increase your desk space by up to 40 percent. Flexible, sleek and streamlined, the M Deskmount Slim Basic Single frees up space and allows positioning of your display for greater productivity.



M Deskmount Slim Basic Single

For screen size:	17"-32"	Space saver
Feature:	75x75,100x100	735007373
VESA standard:	9974 114 x 92 x 615mm	Yes
Article No:	Yes, approx. -5 to 90 degrees	
Size in mm: (H*W*D)	N/A Yes, approx. -180°~+180°	
Fits Curved Screens?	degrees Yes	3.22 kg (weight of
Tilt:	one packed unit) Black 2~8 kg 6	
Swivel:	pcs 5 years	
Rotation of TV plate:	_____	
Cable Management:	_____	
Weight:	_____	
Colour:	_____	
Max load:	_____	
Distribution package:	_____	
Warranty:	_____	

**SPACE
SAVER**

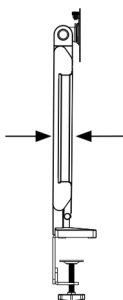

Save 40% desk space!
Designed to fit small
tables and work spaces

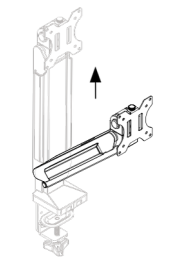

Adjust height
Adjust the height
of the screen

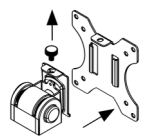

Detachable VESA
Detachable VESA plate
makes installation easy

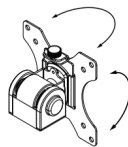

Tilt & swivel
Easily adjust the
screen for better view

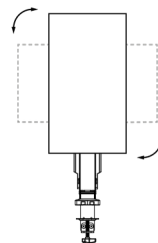

Portrait & landscape
Rotate the screen
for a suitable view

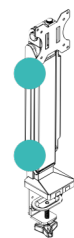

Cable Management
Easily hide your
cables in good order

HIGHLIGHTS

- Space-Saving Design
- Detachable VESA plate makes installation easy
- Built in Cable management
- Adjust height for an optimal ergonomic position

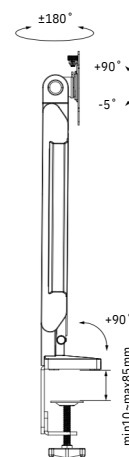
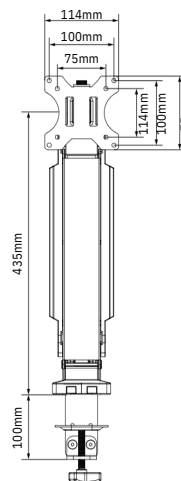



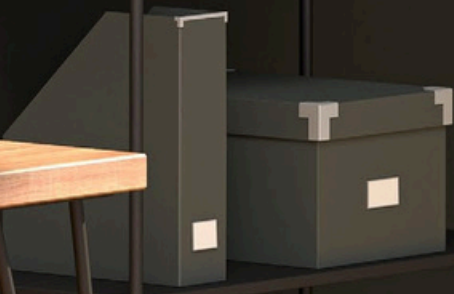

M DESKMOUNT SLIM BASIC DUAL A HIGH-EFFICIENCY WORKSPACE SOLUTION

If your workspace isn't too big and you still want two displays, you should take a closer look at this product.

A well designed high efficiency workspace solution. This product aims at freeing up occupied desk space through a unique design that provides easier maneuverability and capable of moving even to fit flush against a wall. Perfect for displays ranging between 17" and 27" in size, this monitor arm offers height as well as screen angle adjustments for your optimal viewing and ergonomic posture. With a maximum weight capacity of 6.5kg per screen it can be easily mounted on most desktop surfaces with a clamp-on design that reduces installation time.

If your workspace isn't too big and you still want two displays, you should take a closer look at this product.



M Deskmount Slim Basic Single

For screen size:	17"-32"
Feature:	Space saver
VESA standard:	75x75,100x100
Article No:	735007373 9981
Size in mm: (H*W*D)	717 x 128 x 628mm
Fits Curved Screens?	Yes
Tilt:	Yes, approx. -20° to 45° degrees
Swivel:	15°~ -15° degrees
Rotation of TV plate:	Yes, approx. -180°~+180° degrees
Cable Management:	Yes
Weight:	5.56kg (weight of one packed unit)
Colour:	Black
Max load (per screen):	2~6.5kg
Warranty:	5 years

SPACE SAVER

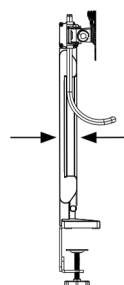

Save 40% desk space!
Designed to fit small
tables and work spaces

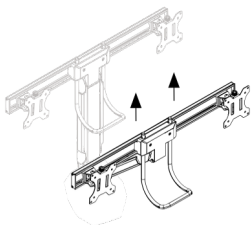

Adjust height
Easily adapt the
height of the screen

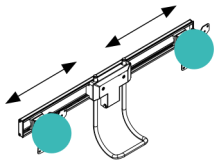

Lateral Shift
Slide each monitor
horizontally with ease

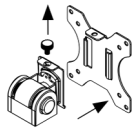

Detachable VESA
Detachable VESA plate
makes installation easy

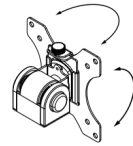

Tilt & swivel
Easily tilt your screen
for better viewing

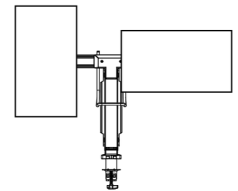

Portrait & landscape
Rotate the screen
for a suitable view

HIGHLIGHTS

- Dual display space-saving design
- Built in handle for easy grip & reposition both screens at once
- Detachable VESA plates makes installation easy
- Lateral shift possible
- Built in Cable management
- Adjust height for an optimal ergonomic position

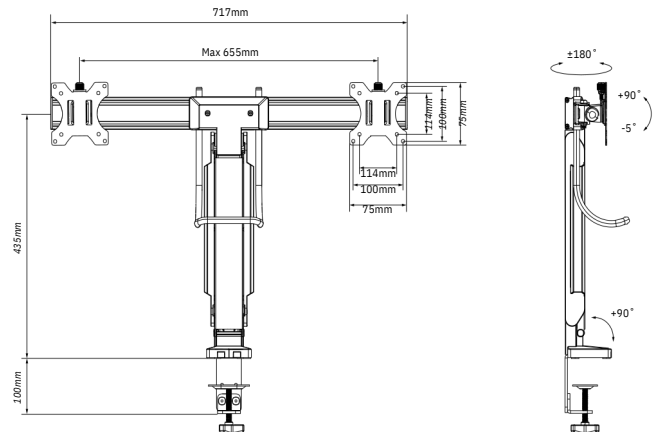





M DESKMOUNT XL THE NEW BIG SIZE LIFESTYLE MONITORS WORKS AS TV AND DISPLAY IN ONE! UP TO 55"

Versatile and affordable 'do-it-all' screen offers flexibility for work, learning and entertainment at home.

This is a height adjustable tabletop mount for large size displays with an ultra slim design. With the increasing demand for large size displays and video conference equipment and more focus on collaborative working, we introduced the M Deskmount XL Black.

Easily Mount 32"-55" Monitors or TVs to a Multimedia Table for Use in Conferences, Displays or Presentations. With support of interactive displays, and other large size displays, our mounts can attach quickly to most any surface and support for video conferences or training, group discussions or presentations in offices, especially in huddle rooms. Rear back hides hardware for a clean look.



**SPACE
SAVER**



Ultra slim
Designed to fit small
tables and work spaces

M Deskmount XL White & Black

Article No:	7350105210129 - Black 7350105210136 - White
Colour:	Black / White
For screen size:	32" - 55"
VESA standard:	75x75, 100x100, 200x200, 300x300, 400x400 35 kg
Max load:	Yes. 440/490/540mm
Height adjustment	Yes
Cable Management:	460 x 150 x 924 mm
Size in mm: (H*W*D)	8.1
Weight:	5 years
Warranty:	

Dual Use
TV & Monitor

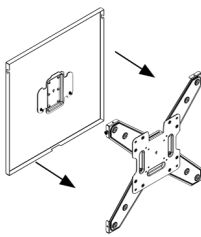

Detachable VESA
Detachable VESA plate makes installation easy

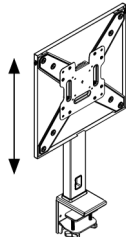

Height adjustment
Height can be adjusted to three different stages

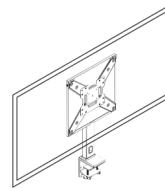

Extra Large Screens
Handles large size screens & displays

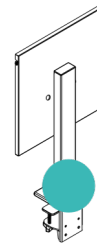

Cable Management
Easily hide your cables in good order

HIGHLIGHTS

- Handles large size displays 32" - 55"
- Ultra slim and space saving
- Three stage height adjustment
- Built in cable management
- Detachable VESA plate
- Elegantly designed back coverplate

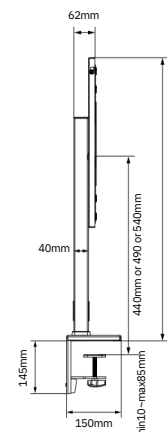
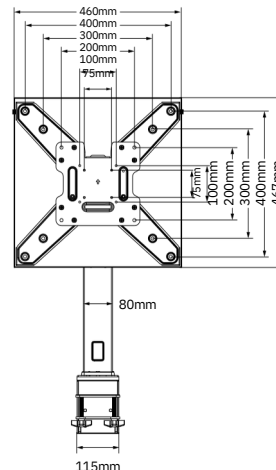





HOME OFFICE

By Multibrackets



DESIGNED &
ENGINEERED
IN SWEDEN

Multibrackets supports your everyday work-from-home

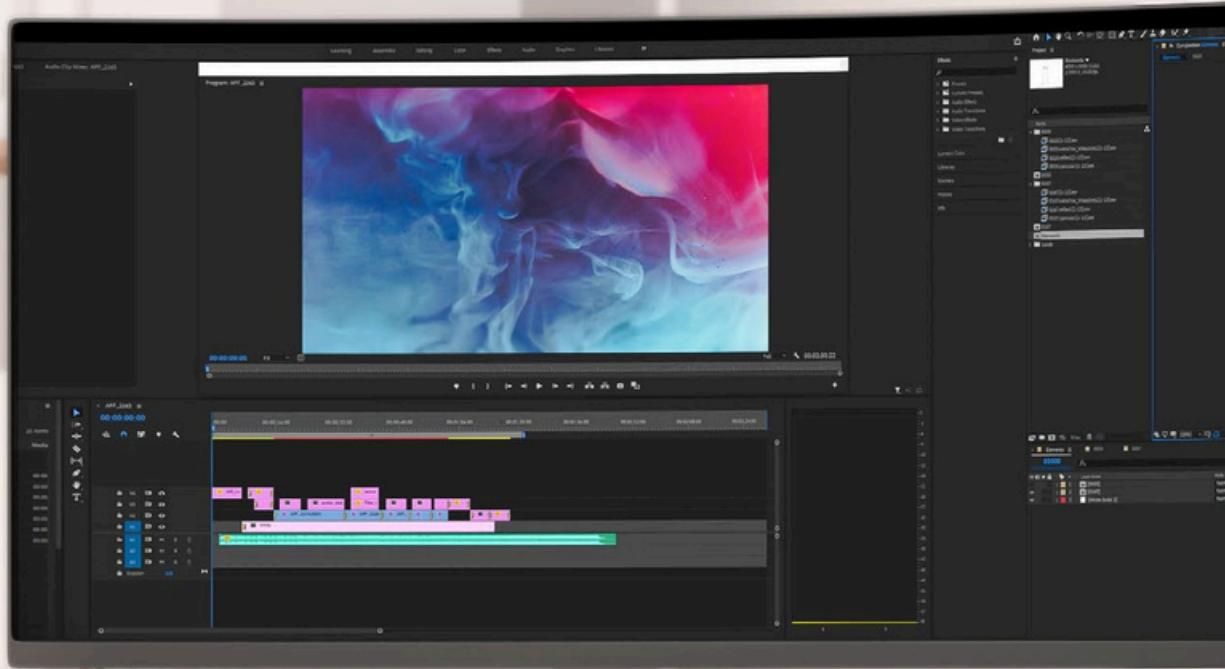

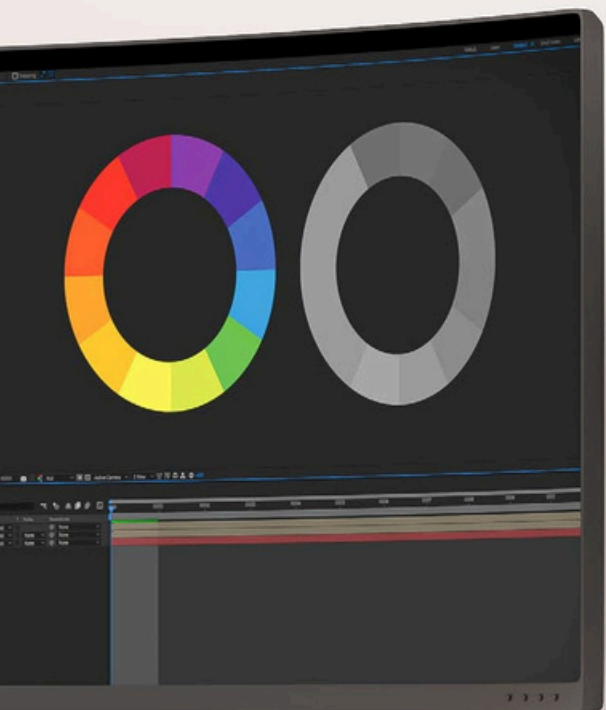

M VESA GAS LIFT ARM SINGLE

UNIQUE GAS TECHNOLOGY THAT PROVIDES SMOOTH ADJUSTMENT IN ANY DIRECTION

A triple jointed gas suspended monitor arm, designed by Multibrackets to optimize your productivity and help reducing strain on neck, back and eyes.

Desk Mounts go beyond simple movements by

offering tool less movement and counter balance weight adjustment. The original M VESA Gas Lift Arms are made out of a durable aluminum construction and uses a gas driven suspension technique. Always finding your best view, saving desk space and letting you discover your most productive self, the M VESA Gas Lift Monitor Arms always deliver.

Place your screen where you need it for each project, and then reclaim a space full of opportunities by folding the arm and pushing it aside during a much needed screen break.

Wide

27" -32"

16:9

27" -37"

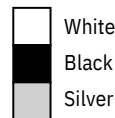

Gas Lift cylinder

M VESA Gas lift Arm Single

Article No:	7350022737174 - Black 7350022737167 - Silver 7350022737150 - White
For screen size:	15-32"
VESA standard:	75x75, 100x100mm
Colour:	Black / silver / white
Screen weight:	Min. 2 kg - Max. 10 kg
Function:	Gas driven piston
Rotate:	90°
Weight:	3,4 kg
Tilt angle:	+75° to -45°
Turn angle:	+90° to -90°
Warranty:	2 years

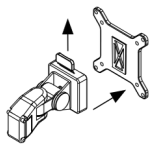

Detachable VESA
For easy installation

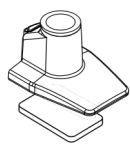

Desk clamp
(included)

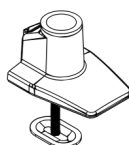

Grommet
(included)

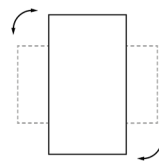

Portrait & landscape
For a suitable view

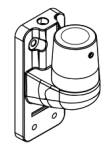

Wall Adapter
(optional)

HIGHLIGHTS

- Move your display to a perfect position, improve your daily use and ergonomics
- This arm easily adjusts monitors up to 32" in size
- Clear your desk and enlarge your working area
- We designed this with both mechanics and aesthetics in mind
- Connects your screen to the arm with a snap
- This gas arm is built to last longer than our competitors by passing our 10 000 cycle motion test

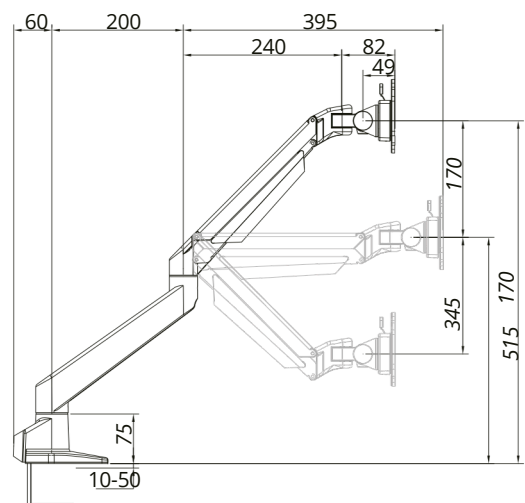

M VESA GAS LIFT ARM

SINGLE XL HD MAKING YOUR WIDESCREEN FLOAT LIKE A FEATHER

Frees up space and allows positioning of your extra large screen for greater productivity.

These Full Motion Univers

offering tool less movement and counter balance weight adjustment. The original M VESA Gas Lift Arms are made out of a durable aluminum construction and uses a gas driven suspension technique.

Always finding your best view, saving desk space and letting you discover your most productive self, the M VESA Gas Lift Monitor Arms always deliver. Place your screen where you need it for each project, and then reclaim a space full of opportunities by folding the arm and pushing it aside during a much needed screen break.

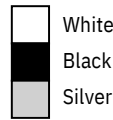

Gas Lift cylinder

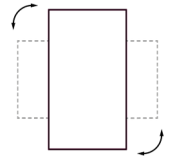

Portrait & landscape
For a suitable view

Wide
27" - 37"
16:9

15" - 55"

M VESA Gas lift Arm Single XL HD

Article No:	7350073737123 - Black 7350073737130 - Silver 7350073737147 - White
For screen size:	15"-49" 75x75, 100x100,
VESA standard:	200x200mm Black / white
Colour:	/ silver Min. 9 kg - Max. 18
Screen weight:	kg Gas driven piston 90°
Function:	4,4 kg +75° to -45° +90° to
Rotate:	-90° 2 years
Weight:	
Tilt angle:	
Turn angle:	
Warranty:	

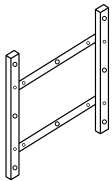
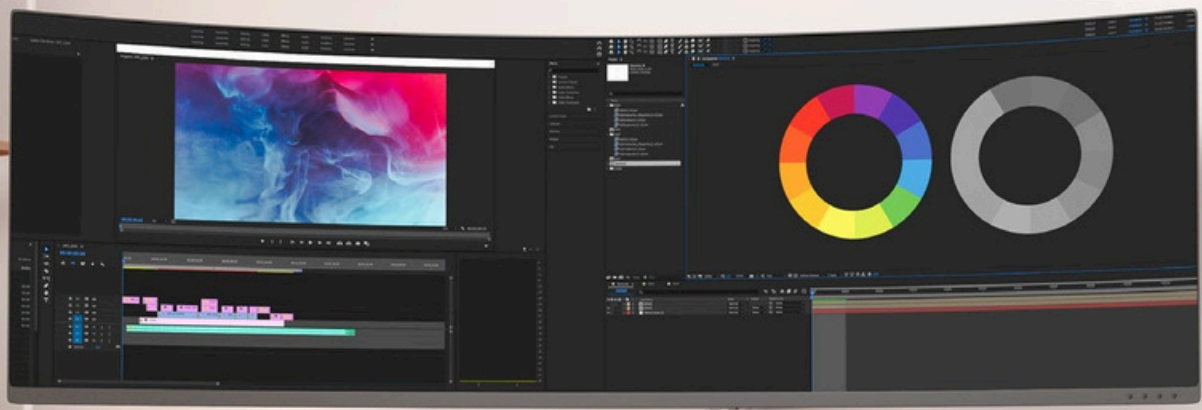

VESA 200x100 & 200x200
For extra large screens

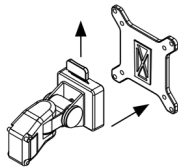

Detachable VESA
Makes installation easy



Desk clamp & grommet
(included)

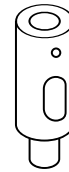

Extension pipe
(included)

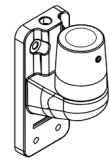

Wall Adapter
(optional)

HIGHLIGHTS

- Move your display to a perfect position, improve your daily use and ergonomics
- This arm easily adjusts monitors up to 32" in size
- Clear your desk and enlarge your working area
- We designed this with both mechanics and aesthetics in mind
- Connects your screen to the arm with a snap
- This gas arm is built to last longer than our competitors by passing our 10 000 cycle motion test

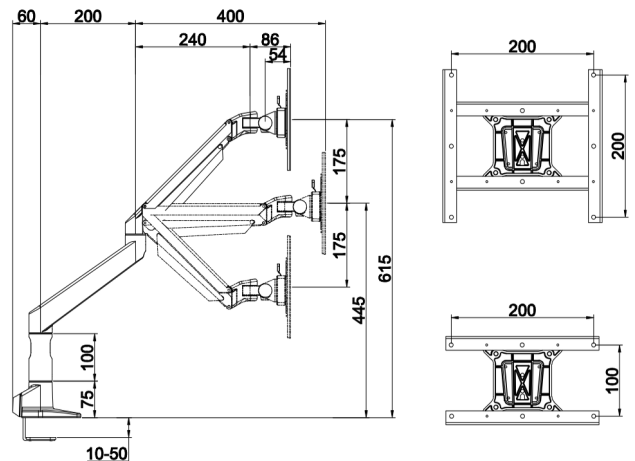





M VESA DESKMOUNT HD

DUAL VERTICAL WIDE 32"-50" STACKING DESKTOP MONITORS INCREASES EFFICIENCY & SAVES SPACE

While desk widths at home often are scarce, ceilings are (so far) staying put. So while you may not have the room to put two or three displays side by side at home, there's almost always ample room to go up, into what is otherwise unused space.

With the new large size

wide screen curved market Multibrackets mounting systems can handle stacked displays as large as twin 50 inch. curved monitors, creating a vast, immersive working canvas .

This is a height adjustable tabletop mount for large size displays with an ultra slim design. With the increasing demand for large size displays and video conference equipment and more focus on collaborative working, we introduced the M Desktop XL Black.

Easily Mount 37"-55" Monitors or TVs to a Multimedia Table for Use in Conferences, Displays or Presentations. With support of interactive displays and other large size displays our mounts can attach quickly to most any surface and support for video conferences or training, group discussions or presentations in offices, especially in huddle rooms. Rear back hides hardware for a clean look.



M VESA Desktopmount Dual Vertical Wide 32"-50"

Article No:	7350105210556	7350105210563	7350105210570
Colour:	Black	Black	Black
Material:	Aluminum / Steel	Aluminum	Aluminum
Weight:	8 kg	0.5 kg	3.1 kg
Measurements:	800x170x190 mm	210x210x40mm	410x395x40mm
Warranty:	5 years	5 years	5 years
For screen size:	32" - 50"		
Tilt:	Yes -15°- +20°		
Swivel:	Yes ±20°		
Rotate:	Yes 360°		
Installation:	Desk clamp, adjustable 10-60 mm		
Universal VESA standard:	75x75 100x100 mm		
Max load:	24 kg per screen		
Adjustable height upper screen:	560-790 mm		
Adjustable height lower screen:	185-415mm		
Cable Management:	Yes		

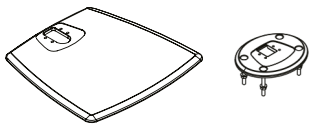
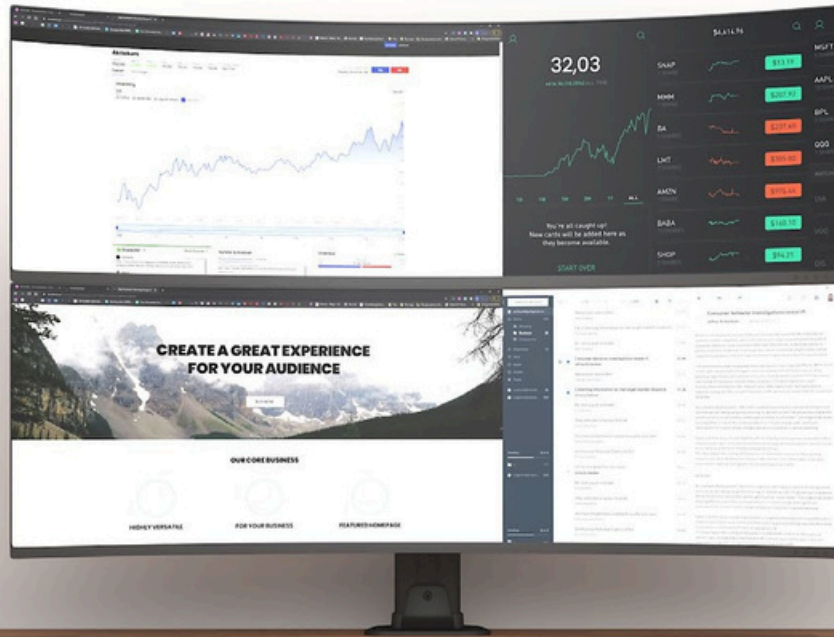

Exchangeable Base
Attach a different base according to your needs

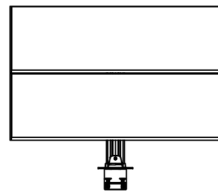

Large Screens
Easily mount two screens on top of each other

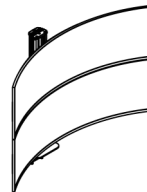

Curved Screens
Specially designed for curved screens

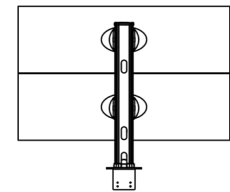

Cable Management
Integrated cable management for clean installation

HIGHLIGHTS

- A high level designed productline for office use
- Made for the professional user
- Creates maximum ergonomic comfort for displays up to 50"
- Simplified installation and simple after adjustment possibilities
- Plexi based cable management (included)
- Optional through hole installation with Grommet Base

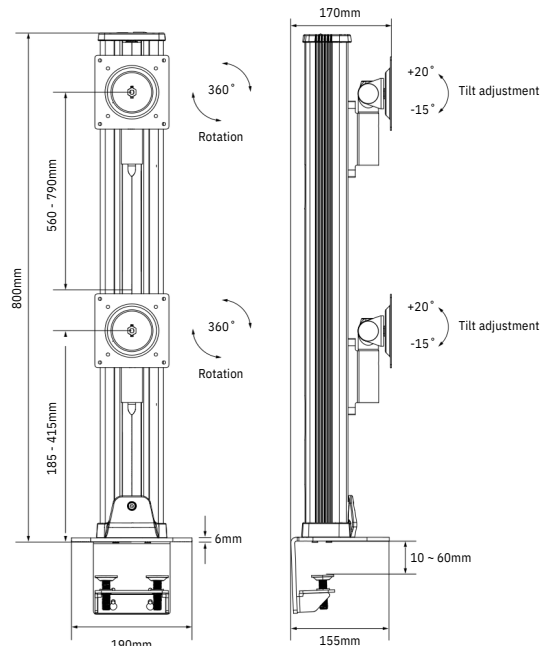

HEADSET HOLDERS

MAKING YOU AND YOUR OFFICE DESK STAND OUT!

Brass, copper, stainless steel. A headset stand in solid metal, heavy weight.

Looking for a premium level headset stand for you

Headset stands have become a classic. Often copied and imitated but never duplicated, today the Standard, 'how an exclusive headset stands should look'. So, keep your on ear headphones secure and above all, neat, hanging freely in the air they are unstressed, ensuring a long lasting, good fit, and all whilst being displayed as if in a boutique store.

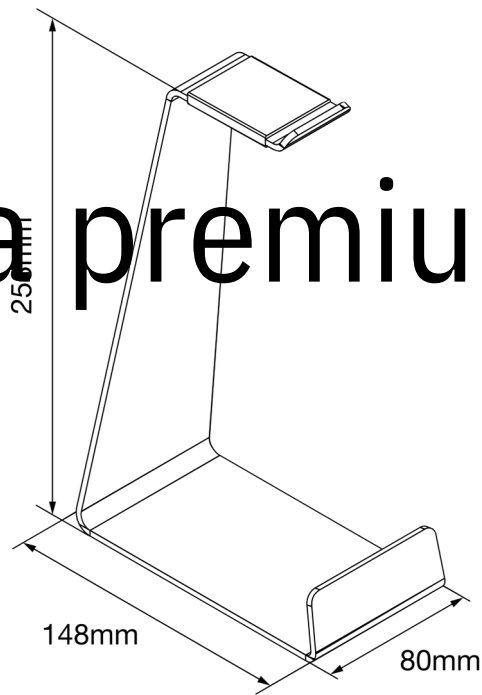

Table Stands



Article No:	7 350 073 731 893	7 350 073 732 050	7 350 073 731 862	7 350 073 732 845	7 350 073 732 852	7 350 073 734 610
Product measurements:	253x148x80mm	253x148x80mm	253x148x80mm	253x148x80mm	253x148x80mm	253x148x80mm
Weight:	272 g	272 g	272 g	272 g	272 g	272 g
Colour:	Black	Silver	White	Brass	Copper	Stainless Steel
Max load:	1 kg	1 kg	1 kg	1 kg	1 kg	1 kg
Gift box measurements:	260x150x80mm	260x150x80mm	260x150x80mm	260x150x80mm	260x150x80mm	260x150x80mm
Warranty:	5 years	5 years	5 years	5 years	5 years	5 years



- HIGHLIGHTS**
- Uniquely designed and handmade
 - The original universal Headphones stand
 - Made out of one piece solid material
 - Makes your office desk stand out

Desk



Wall



	7 350 073 731 886	7 350 073 732 043	7 350 073 731 855	7 350 073 731 879	7 350 073 732 036	7 350 073 731 848
Article No:	7 350 073 731 886	7 350 073 732 043	7 350 073 731 855	7 350 073 731 879	7 350 073 732 036	7 350 073 731 848
Product measurements:	112x56x40mm	112x56x40mm	112x56x40mm	112x56x40mm	112x56x40mm	112x56x40mm
Weight:	52 g	52 g	52 g	37 g	37 g	37 g
Colour:	Black	Silver	White	Black	Silver	White
Max load:	1 kg	1 kg	1 kg	1 kg	1 kg	1 kg
Gift box measurements:	120x60x45mm	120x60x45mm	120x60x45mm	120x60x45mm	120x60x45mm	120x60x45mm
Warranty:	5 years	5 years	5 years	5 years	5 years	5 years

CABLE SOCKS

ELEGANT RESISTANCE FOR DELICATE CABLES

25m rolls!

Versatile, with flexible properties Cable Socks gives abrasion resistance for delicate cables.



Leaving delicate cables

exposed to the outside of costly abrasive damage and UV degradation. Adding Multibrackets cable sock solutions to cables in high traffic or high friction areas will help extend cable life and save you money down the road. Unlike traditional braided sleeving or wire loom, these cable socks install easily with no special tools or endless sliding. Our unique colour options also allow colour coding and easy identification of cable infrastructure. A good choice for AV cables, computer cables (inside and out), server halls, datacentres optical cables (5mm version), hospitals, hotel rooms and anywhere else one might need high quality cable socks. Our Cable Socks are also fire retardant.

M Universal Cable Socks Self Wrapping

Material:	Polyester
Self wrapping:	Yes
Sock length:	25 m
Working temp. :	-50°C+ 150°C
Melting point:	240±10°C
Flammability:	8s6853 lb UL94 V-0 FMVSS 302
Monofilament diameter:	0.25mm
Safety:	Fire retardant material
Certificate:	RoHS
Warranty:	5 years
Weight:	Depending on size

Wear-resisting level:
ISO6722, Load 7N, Number of scratches ≥3000 times, high wear resistance.

Application:
It is widely used in electrical wiring, cables, wiring harness and hoses for high-speed trains, cars, automation equipment, instruments, and especially for irregularly wiring harness.

Model:	M Cable Sock Heat Cutter
Article No:	7 350 022 732 926
Colour:	Light Blue
Warranty:	1 year





































Model:	M Cable Sock Quicktool
Article No:	7 350 073 734 689
Colour:	Blue
Warranty:	1 year

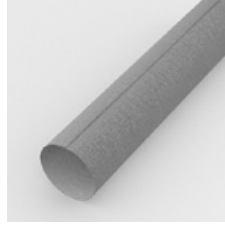

HIGHLIGHTS

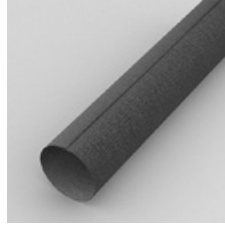
- Expands easily to ensure complete coverage and protection.
- Offers general protection from abrasion, chemicals and temperature for optimal protection.
- Available in various sizes and colors.
- Designed to adjust and expand to irregular shapes.
- Keeps its flexibility under a wide range of temperatures and over time.
- Constructed from tightly woven polyester material.
- Provides easy installation on already existing applications simply unwrap the cable sock and apply directly to your cable or product.
- Highly versatile with flexible properties, excellent for office/ commercial/ industrial uses.

Diameter:	5mm - 9mm	10mm - 14mm	19mm - 30mm	25mm - 35mm	40mm - 50mm
YELLOW	 7 350 073 734 382	 7 350 073 734 429	 7 350 073 734 467	 7 350 073 734 504	 7 350 073 734 542
ORANGE	 7 350 073 734 399	 7 350 073 734 436	 7 350 073 734 474	 7 350 073 734 511	 7 350 073 734 559
RED	 7 350 073 734 412	 7 350 073 734 450	 7 350 073 734 498	 7 350 073 734 535	 7 350 073 734 573
BLUE	 7 350 073 734 405	 7 350 073 734 443	 7 350 073 734 481	 7 350 073 734 528	 7 350 073 734 566
WHITE	 7 350 073 733 194	 7 350 073 733 224	 7 350 022 734 203	 7 350 073 732 777	 7 350 073 732 807
GREY	 7 350 073 733 200	 7 350 073 733 231	 7 350 022 734 180	 7 350 073 732 784	 7 350 073 732 814
BLACK	 7 350 073 733 217	 7 350 073 733 248	 7 350 022 734 197	 7 350 073 732 791	 7 350 073 732 821



“Everything starts with you.

For us to create great products it always begins with putting you the user at the heart of everything we do.”

Mission We are on a mission to create products that are simple to install and use, that excites and solves our clients daily needs - everyday, all year around. Based in Stockholm, Sweden we design, develop and market AV Equipment. But we do it our way. Armed with a genuine passion for new technology and user centric innovation, we take a product and give it a little bit of Multibrackets magic!

About us Founded in year 2000 we are a family owned business and represented in over 30 countries. Today we are considered one of the leaders in the rapidly changing environment of digital signage technology – together with our distributors we are providing hardware and services to enable the full value from idea to a ready product. With one of the most comprehensive product lines in EU we supply Audio Visual Equipment for every need. Multibrackets reputation for innovative products is well known.

Become a partner Stay ahead of your competition – Let us help you become a partner. Simply send us an email on support@multibrackets.com or go to our webpage <https://products.multibrackets.com/en/contact> for a contact with us at Multibrackets and we will help you with a distributor’s contact. We look forward to your email.

Contact details

Multibrackets Europe AB
Döbelnsgatan 21, 11th floor
SE-111 40 Stockholm
SWEDEN

Reach us on email support@multibrackets.com or phone +46 (0)8 - 615 04 00

Sustainability At Multibrackets we see sustainability like a journey. Being in the AV business means we have a responsibility to take care of the environment and everybody who plays a part in making our products. We are working hard to design sustainable products, minimize our impact on the environment, improve our sourcing and create a great workplace for our employees. Find out more about what we are doing and what we’ve already achieved on our web.

Copyright This catalogue is protected by copyright laws. The graphic design, content, and images in this catalogue may not be reproduced, published displayed, or reproduced in any way, in whole or in part. This catalogue is considered the intellectual property of Multibrackets Europe AB, and we respectfully ask that you not copy, transmit, distribute, or create a derivative work based upon the content and materials of this catalogue. The content is also subject to the copyright laws of EU and the US (Act of 1976, Title 17 of the United States Code) and may not be copied for use in your publications or newsletters without prior written consent of Multibrackets Europe AB. If you are a customer of Multibrackets Europe AB and would like permission to use one of our articles in your company publication, please email and we would be happy to consider giving you permission to do so, as long as you would be willing to credit your source (Multibrackets Europe AB).

We reserve ourselves for printing errors Printing errors. While we strive to display all our information as correct as possible, there sometimes occurs misprinting’s and faulty information in catalogues. If this happens, and it should affect in any way the forms of, for example faulty product information, or the alike, we will inform you as soon as we notice, and amend it. Please note that we reserve ourselves the right to cancel any order that has been sold presented with a misprinted information. Editing, deleting, or modification of this catalogue: We reserve the right, for any reason, to edit this catalogue. That means, without advance notice, we may suspend, discontinue, edit, or delete current information, products, services, or any other content appearing in this catalogue.

Again, Welcome to Multibrackets Europe, one of the leading manufacturers of Audio Visual Equipment in Europe.

All rights reserved, Multibrackets® Stockholm, Sweden, 2019 / 2020



Official Distributor

MAJAR Group of Companies – Matzaridis Bros S.A.

I. Tsalouchidi 16 - 20, Business Center, 54248, Thessaloniki, Greece

Tel.: +30 2310 928 851

www.majar.gr - info@majar.gr



Multibrackets Europe AB

Phone: +46(0)8- 615 04 00 E-mail: support@multibrackets.com

Postal address: Döbelnsgatan 21, 11th floor SE-111 40 Stockholm Sweden

