

2024



RV & OUTDOOR CATALOGUE

ABOUT VANLIFE & OUTDOOR SPIRIT





ALWAYS ON YOUR ADVENTURE

The ideal temperature on hot and muggy summer nights, enjoying a cold drink always at hand and all the space you need to store food without shopping every day.

They are small comforts that we take for granted at home but that become small daily pleasures during our adventures in campers and van. We want to make your travel more comfortable, more practical and more carefree with efficient, reliable products and smart refrigeration solutions you can always count on.

IT

La temperatura ideale nelle notti calde e afose d'estate, il piacere di una bibita fresca sempre a portata di mano e tutto lo spazio di cui hai bisogno per conservare il cibo senza fare la spesa ogni giorno. Sono piccoli comfort che diamo per scontato tra le mura domestiche ma che diventano piccoli piaceri quotidiani durante le nostre avventure in camper e van. Vogliamo rendere il vostro viaggiare più comodo, più pratico e più spensierato con prodotti efficienti, affidabili e soluzioni di refrigerazione smart sulle quali poter sempre contare.

DE

Die ideale Temperatur in feuchtheißen Sommernächten, der Genuss eines zu jeder Zeit verfügbaren kühlen Getränks und ausreichend Platz für Lebensmittel, ohne jeden Tag einkaufen zu müssen. Ein kleiner Komfort, den wir zu Hause für selbstverständlich halten, der aber bei unseren Wohnmobil- und Van-Abenteuern zu kleinen täglichen Freuden wird. Wir leisten unseren Beitrag, damit Ihre Reisen komfortabler, bequemer und sorgenfreier werden: Effiziente, zuverlässige Produkte und intelligente Kühllösungen, auf die Sie sich immer verlassen können.

Our goal is to give you reliable and thoughtfully designed 12V air conditioning and refrigeration solutions that help make every journey you take a perfect outdoor experience.

OFF products are designed to handle any travel conditions; our continuous technology improvement philosophy means you can explore life in a camper or van with confidence in the equipment on board.

INSPIRED
BY TRAVELLERS
DESIGNED
FROM EXPERIENCE

IT

Viaggio dopo viaggio, il nostro obiettivo è offrire prodotti 12V per la climatizzazione e refrigerazione affidabili e di design ai nostri clienti ovunque si trovino, perché sappiamo cosa serve per vivere l'esperienza outdoor perfetta.

I prodotti OFF sono progettati per fare la differenza in qualsiasi condizione di viaggio; nascono da un processo continuo di evoluzione tecnologica per esplorare costantemente nuove opportunità per chi si aspetta il massimo dalla vita in camper e van.

DE

Reise für Reise ist es unser Ziel, den Kunden zuverlässige, designorientierte 12V Klima- und Kälteprodukte zu bieten, egal wo sie sind, denn wir wissen, was für ein perfektes Outdoor-Erlebnis erforderlich ist.

OFF-Produkte sind so konzipiert, dass sie unter allen Reisebedingungen einen Unterschied machen; sie sind das Ergebnis eines kontinuierlichen und technologischen Entwicklungsprozesses, um ständig neue Möglichkeiten für diejenigen zu bieten, die vom Leben im Wohnmobil und Van nur das Beste erwarten.





LESS CONSUMPTION MORE FREEDOM

OFF range of products is 12V powered, designed to obtain maximum performance for air conditioning and refrigeration of food and drinks using the lowest battery power consumption and optimized for solar energy operation.

OFF collection represents the synthesis of Indel B iconic branded products with new evolutions in design, efficiency and leisure vehicle compatibility; ideally suited from the most compact camper vans to bigger motorhomes.

IT

Tutta la gamma dei prodotti OFF è 12V, progettata per ottenere il massimo delle prestazioni per la climatizzazione e la refrigerazione di cibi e bevande con il minor consumo di corrente della batteria e ottimizzati per il funzionamento ad energia solare. La collezione OFF è la sintesi tra l'evoluzione di prodotti icona del brand Indel B, rinnovati nel design e ancora più efficienti sotto il punto di vista della refrigerazione e dei consumi, e nuove soluzioni intelligenti per integrarsi alla perfezione in qualsiasi mezzo: dai furgoni camperizzati e van, fino a camper e motorhome di dimensioni generose.

DE

Die gesamte OFF-Produktpalette ist für 12V ausgelegt und garantiert maximale Leistung für die Klimatisierung und Kühlung von Lebensmitteln und Getränken bei geringstem Stromverbrauch. Sie ist außerdem für den Betrieb mit Solarstrom vorgerüstet. Die Kollektion OFF ist die technologische Weiterentwicklung der modernen Produkte von Indel B, die im Design erneuert und in Bezug auf Kühlung und Verbrauch noch effizienter wurden. Neue intelligente Lösungen, die sich perfekt in jedes Fahrzeug integrieren lassen: von Vans bis hin zu Integrierten und Teilintegrierten mit großzügigen Abmessungen.



Piombino, Isola d'Elba, Italy

From moon landing to the invention of laser, the 1960s marked a time of world innovation. With this mindset, Indel B was born in 1967 in the areas where the Italian automotive industry was most fruitful. The Company launched on the international market with the first 12 or 24V DC semi-hermetic compressor planned and designed in Italy. In this general idea of freedom and change, the first refrigerator with compressor was created, completely changing the idea of comfort outside the domestic walls and during the long trips of transporters. This spirit of innovation, the visionary eye on customer's future needs, and important investments in research and development allowed Indel B to move from one sector to another, showing its know-how and Technical Data abilities. Today Indel B is a solid reality quoted on the stock market, with an unprecedented record of iconic pieces which have changed the way we live outdoors: excellent collaborations in every field, and the intention to keep developing the outdoor sector with OFF products.

WE MAKE IT BETTER

IT

Dall'allunaggio all'invenzione del laser, gli anni '60 hanno segnato nel mondo un'epoca di innovazione. Con questo spirito, nelle terre in cui lavora il meglio dell'industria automotive italiana, nel 1967 nasce Indel B che si lancia sul mercato internazionale con il primo compressore semi ermetico DC 12 o 24 Volt progettato e disegnato in Italia. Nella sensazione di libertà e cambiamenti che si respira nell'aria, prende vita il frigo portatile con compressore, che cambia radicalmente il comfort fuori dalle mura domestiche e nei lunghi viaggi dei trasportatori. Questo spirito innovativo, l'occhio visionario sulle future necessità dei clienti e importanti investimenti in ricerca e sviluppo portano Indel B a spostarsi di settore in settore, conquistandoli con i propri know-how e qualità tecniche. Oggi Indel B è una realtà solida quotata in borsa, con uno storico di primati e pezzi iconici che hanno cambiato le modalità di vivere il fuori, collaborazioni con eccellenze di ogni campo, e l'intenzione di rivoluzionare ancora di più il settore dell'outdoor con la linea OFF.

DE

Von der Mondlandung bis zur Erfindung des Lasers, markierten die 1960er Jahre eine Ära der Innovation in der Welt. Mit diesem Geist, wurde 1967 Indel B in dem Gebiet gegründet, in dem die besten der italienischen Automobilindustrie arbeiten und so wird der erste halbhermetische Kompressor DC 12 oder 24 Volt, der in Italien entworfen und konstruiert ist, dem internationalen Markt vorgestellt. Mit dem Gefühl von Freiheit und Wandel das einen umgibt, erwacht der tragbare Kühlschrank mit Kompressor zum Leben, was den Komfort außerhalb des Hauses und auf den langen Fahrten der Transporteure radikal verändert. Dieser innovative Geist, ein visionärer Blick auf zukünftige Kundenbedürfnisse und große Investitionen in Forschung und Entwicklung führten dazu, dass Indel B von Sektor zu Sektor wechselte und mit seinem Know-how und seinen technischen Qualitäten überzeugte. Heute ist Indel B ein solides börsennotiertes Unternehmen, mit einer Historie an Erfindungen und ikonischen Stücken, die die Art und Weise des Outdoor-Lebens verändert haben, Kooperationen von Exzellenz in jedem Bereich und der Absicht, den Outdoor-Sektor mit der OFF-Linie noch mehr zu revolutionieren.

1967: Indel B was born, as well as the first 12 or 24V DC semi-hermetic compressor.

IT

1967: nasce Indel B e il primo compressore semi ermetico DC 12 o 24V.

DE

1967: entsteht Indel B und der erste halbhermetische Kompressor DC 12 oder 24V.

Innovation continues with the first LT22 12 or 24V portable compressor refrigerator.

IT

L'innovazione continua con il primo frigo portatile a compressore LT22 12 o 24V.

DE

Die Innovation geht weiter, mit dem ersten tragbaren Kühlschrank, kompressorbetrieben durch LT22 12 oder 24V.

Since 1972, Indel B has opened up to the market of 12 or 24V built-in compressor refrigerators for recreational vehicles.

IT

Dal 1972 Indel B apre il mercato dei frigoriferi da incasso a compressore 12 o 24V per veicoli ricreazionali.

DE

Ab 1972 eröffnet Indel B den Markt für Einbaukühlschränke mit Kompressor 12 oder 24V für Freizeitfahrzeuge.

A new European record is the first DC air conditioning.

IT

Un nuovo primato europeo è la prima aria condizionata a corrente continua.

DE

Eine neue europäische Erfindung ist die erste tragbare Klimaanlage mit Kompressor und Gleichstrom.



The corporate group, listed on the stock exchange, exceeds 220 million of turnover with important industrial and commercial activities in China, America, and South America.

IT

Il Gruppo quotato in borsa supera i 220 milioni di fatturato con importanti attività industriali e commerciali in Cina, America e Sud America.

DE

Die börsennotierte Gruppe überschreitet 220 Millionen Umsatz mit wichtigen industriellen und kommerziellen Aktivitäten in China, Amerika und Südamerika.

Plein-Aircon 12V gives life to a new concept for mobile air conditioning.

OFF is the first 12V line entirely dedicated to recreational outdoor life.

IT

Con Plein-Aircon 12V si apre un nuovo concetto di aria condizionata mobile. Nasce OFF, la prima linea interamente dedicata all'outdoor ricreazionale a 12V.

DE

Mit Plein-Aircon 12V eröffnet sich ein neues Konzept der mobilen Klimatisierung. OFF ist geboren, die erste Linie, die vollständig der Outdoor-Freizeitgestaltung bei 12V gewidmet ist.

Indel B starts collaborating with international companies, designing the first compressor refrigerator for the leisure market.

IT

Iniziano le prime collaborazioni internazionali: Indel B progetta per i produttori di recreational vehicles i primi frigoriferi a compressore per il mercato del tempo libero.

DE

Es beginnen die ersten internationalen Zusammenarbeiten: Indel B entwickelt die ersten Kompressor-Kühlschränke für den Freizeitmarkt.

THE ONLY REAL COOLING TECHNOLOGY.



The compressor cooling technology developed by Indel B is more than just an alternative: it is the only real solution that will satisfy traveller's needs, in every situation.

No other technology performs so well: the trivalent and thermoelectric systems consume way more. Indel B's know-how on this technology has resulted in the creation of products without equals, designed to adapt to the most intense use on the road.

+ Quick

The quick decrease in the refrigerator's temperature by 21° C in just 30 minutes makes it appropriate for all needs, even in a hectic life on the road.

L'abbassamento rapido della temperatura del frigorifero di 21° C in appena 30 minuti lo rende adatto a ogni necessità, anche in una frenetica vita on the road.

Die schnelle Absenkung der Temperatur des Kühlschranks um 21° C in nur 30 Minuten macht ihn für jeden Bedarf geeignet, auch für das hektische Leben „on the road“.

+ Silence

Years of experience in the automotive field have allowed us to hone the compressor technology in order to significantly reduce the noise level. As a matter of that all our products are suitable for any circumstances and conditions of use, even at night.

Anni di esperienza in campo automotive ci hanno permesso di affinare la tecnologia del compressore riducendone sensibilmente i rumori e rendendolo così adatto ad ogni contesto e condizione d'uso anche notturno.

Unsere jahrelange Erfahrung im Automobilbereich hat es uns ermöglicht, die Kompressortechnologie zu verfeinern, um den Geräuschpegel deutlich zu senken. Deshalb sind alle unsere Produkte für alle Umstände und Einsatzbedingungen geeignet, auch bei Nacht.

+ Performance

An unprecedented technology allows the device to reach unimaginable performances, up to -20° C with a starting temperature of 25° C.

Una tecnologia senza pari permette al dispositivo di produrre performance inarrivabili, capaci di raggiungere i -20° C con una temperatura ambiente di partenza di 25° C.

Eine unvergleichbare Technologie ermöglicht dem Gerät eine unübertroffene Leistung zu erzeugen, die bis zu -20° C erreichen kann, bei einer Umgebungstemperatur von 25° C.

+ Flexibility

The keyword for this technology is independence; with its low consumption allows the use of solar panels to prolong its use in plain-air.

Indipendenza è la parola chiave di questa tecnologia, che con i suoi bassi consumi permette l'utilizzo di pannelli solari per prolungare le sue funzioni nella vita in plain-air.

Unabhängigkeit ist das Schlüsselwort dieser Technologie, die mit ihrem geringen Stromverbrauch den Einsatz von Solarkollektoren ermöglicht, um ihre Funktionen im Freien zu verlängern.

IT

La tecnologia di raffreddamento a compressore sviluppata da Indel B non è solo una possibile alternativa, ma l'unica realmente in grado di soddisfare le aspettative di ogni viaggiatore, in ogni contesto. Nessun'altra opzione ne raggiunge le prestazioni: i sistemi termoelettrici e trivalenti ne superano di gran lunga i consumi. Il know-how di Indel B su questa tecnologia le ha permesso di creare prodotti senza pari sul mercato, progettati appositamente per adattarsi anche al più intenso uso on the road.

DE

Die von Indel B entwickelte Kompressor-Kühltechnologie ist nicht nur eine mögliche Alternative, sondern die einzige, die wirklich die Erwartungen jedes Kunden in jedem Kontext erfüllt. Keine andere Option erreicht ihre Leistung: die dreiwertigen thermoelektrischen Systeme übersteigen ihren Verbrauch bei weitem. Das Know-How von Indel B in dieser Technologie hat es ihnen ermöglicht, Produkte zu entwickeln, die auf dem Markt einzigartig sind und die speziell entwickelt wurden, um sich selbst an die intensivste Nutzung auf der Straße anzupassen.

+ Efficiency

The compressor system is without equals when it comes to operational autonomy: power consumption is reduced by 7 times compared to a trivalent system, and 4 times compared to a thermoelectric system.

Il sistema a compressore non ha rivali in termini di autonomia di funzionamento: il consumo energetico è fino a 7 volte meno di un sistema trivalente e 4 volte meno di uno termoelettrico.

Das Kompressorsystem ist in Bezug auf die Betriebsdauer konkurrenzlos: Der Energieverbrauch ist bis zu 7 Mal geringer als bei einem dreiwertigen und 4 Mal geringer als bei einem thermoelektrischen System.



Index



12V AIR CONDITIONER

ARIA CONDIZIONATA 12V
KLIMATECHNIK 12V

Plein-Aircon 12V	NEW DIFFUSER 2024	26
Sleeping Well Cube 12V		42

INSTALLATION REFRIGERATORS

FRIGORIFERI DA INSTALLAZIONE
EINBAUKÜHLSCHRÄNKE

Slim	50
Cruise	56
Elite	64
Drawer	72
Top Loaded	80
Special	86

PORTABLE REFRIGERATORS

FRIGORIFERI PORTATILI
TRAGBARE KÜHLSCHRÄNKE

Steel	98
Travel Box	106
LiON Cooler	114

TRAVEL SAFETY

SICUREZZA IN VIAGGIO
SICHERHEIT AUF REISEN

Safe Box	122
----------	-----



Val d'Orcia, Tuscany, Italy



12V AIR CONDITIONER

ARIA CONDIZIONATA 12V

KLIMATECHNIK 12V

Plein-Aircon 12V

26

Sleeping Well Cube 12V

42

The revolution of mobile 12V air conditioners.

The range of Indel B's OFF air conditioner systems is a synonym for innovation, efficiency, and practicality, with products run on 12V and designed to offer great flexibility and comfort, especially in small spaces and when there is little access to traditional power sources.

Compared to the other solutions on the market, Indel B's 12V technology for air conditioners is an absolute innovation that gives life to a new category of revolutionary products, developing the traditional plain-air cooling concept, overcoming the technology, efficiency and usability of the current systems on the market.

IT

La rivoluzione dell'aria condizionata mobile 12V.

La gamma di sistemi di condizionamento OFF by Indel B è sinonimo di innovazione, efficienza e praticità, con prodotti alimentati a 12V progettati per offrire grande flessibilità e comfort soprattutto in situazioni di spazio limitato e scarsa accessibilità alla rete elettrica tradizionale.

La tecnologia Indel B a 12V applicata nel mondo dell'aria condizionata è un'innovazione assoluta che inaugura una nuova categoria di prodotto rivoluzionando di fatto il concetto di condizionamento in plain-air che supera in termini di tecnologia, efficienza e usabilità gli attuali sistemi presenti sul mercato.

DE

Die Revolution der mobilen Klimaanlage.

Die Palette der Klimaanlage OFF von Indel B ist gleichbedeutend mit Innovation, Effizienz und Praktikabilität. Die mit 12V betriebenen Produkte bieten große Flexibilität und Komfort, insbesondere in Situationen mit begrenztem Platzangebot und schlechter Zugänglichkeit der traditionellen Stromversorgung.

Im Vergleich zu den auf dem Markt erhältlichen Lösungen ist die in der Welt der Klimatisierung angewandte 12V Indel B-Technologie eine absolute Innovation, die eine neue Produktkategorie einführt und das Konzept der Kühlung im Freien revolutioniert, welche die derzeit auf dem Markt erhältlichen Systeme in Bezug auf Technologie, Effizienz und Benutzerfreundlichkeit übertrifft.

Products



Plein-Aircon 12V

POWERED BY SAMSUNG

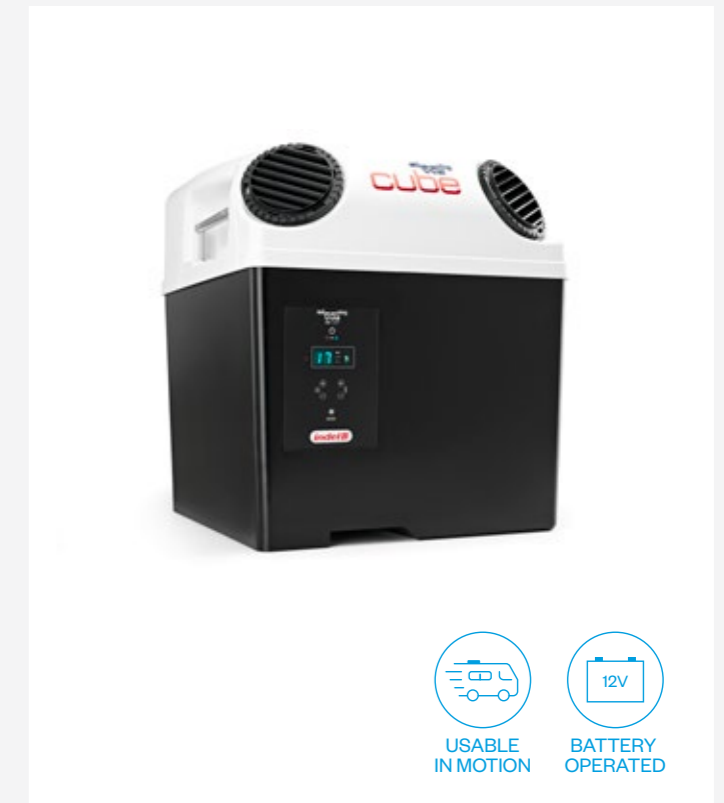

Sleeping Well Cube 12V

POWERED BY SECOP

COULD IT GET EVEN BETTER? YES.



Plein-Aircon 12V RINGLIGHT & LIGHTBOX

A FURTHER STEP INTO THE REVOLUTION



USABLE
IN MOTION



BATTERY
OPERATED



REMOTE
APP CONTROL

INNOVATIVE
12V
AIR CONDITIONING
SYSTEM

EN

The iconic Plein-Aircon model from the OFF line by Indel B goes even further: the first 12V air conditioner for camper vans and semi-integrated vehicles powered by only an auxiliary battery is now available in two models with unique features. Two different air conditioners that meet different functional, aesthetic and structural needs. Two solutions that allow each traveller to explore their own personal outdoor experience, without formal constraints nor on already mapped out routes. The Plein-Aircon 12V RINGLIGHT and the Plein-Aircon 12V LIGHTBOX translate the OFF experience and desire for off-road freedom into new ways of use and unprecedented functionality.

IT

L'iconico Plein-Aircon di OFF by Indel B si spinge ancora oltre: il primo condizionatore a 12V per campervan e semi-integrati alimentato con sola batteria ausiliaria si evolve in due modelli dalle caratteristiche uniche. Due diffusori diversi che rispondono a necessità funzionali, estetiche e strutturali differenti. Due soluzioni che permettono a ogni viaggiatore di esplorare la propria personale esperienza en plein air, senza vincoli formali o strade già delineate. Plein-Aircon 12V RINGLIGHT e Plein-Aircon 12V LIGHTBOX traducono l'esperienza e la voglia di libertà off-road di OFF in nuovi modi di utilizzo e funzionalità inedite.

DE

Die kultige Plein-Aircon von OFF by Indel B geht noch einen Schritt weiter: Die erste 12V-Klimaanlage für Campervans und teilintegrierte Wohnmobile, die ausschließlich über die Hilfsbatterie betrieben wird, wird zu zwei Modellen mit einzigartigen Eigenschaften weiterentwickelt. Mit zwei verschiedenen Klimageräten werden unterschiedliche funktionale, ästhetische und strukturelle Anforderungen erfüllt, so dass alle Mitreisenden ihren Urlaub im Freien in vollen Zügen genießen können – frei von technischen Einschränkungen und fernab von ausgefahrenen Routen. Plein-Aircon 12V RINGLIGHT und Plein-Aircon 12V LIGHTBOX vereinen das Know-how von OFF und Ihre Abenteuerlust zu neuen Nutzungsmöglichkeiten und unvergleichlicher Funktionalität.





A FURTHER STEP INTO THE REVOLUTION

Plein-Aircon 12V RINGLIGHT

Unlocks expressive creativity



NEW AIRFLOW
TECHNOLOGY



ULTRA
SILENT



PERIMETRIC
WHITE LIGHT



PERIMETRIC
BLUE LIGHT



SMART
MAINTENANCE



CUSTOMIZABLE
PANEL



6 SMART
MODE



TOUCH
DISPLAY



REMOTE
APP CONTROL

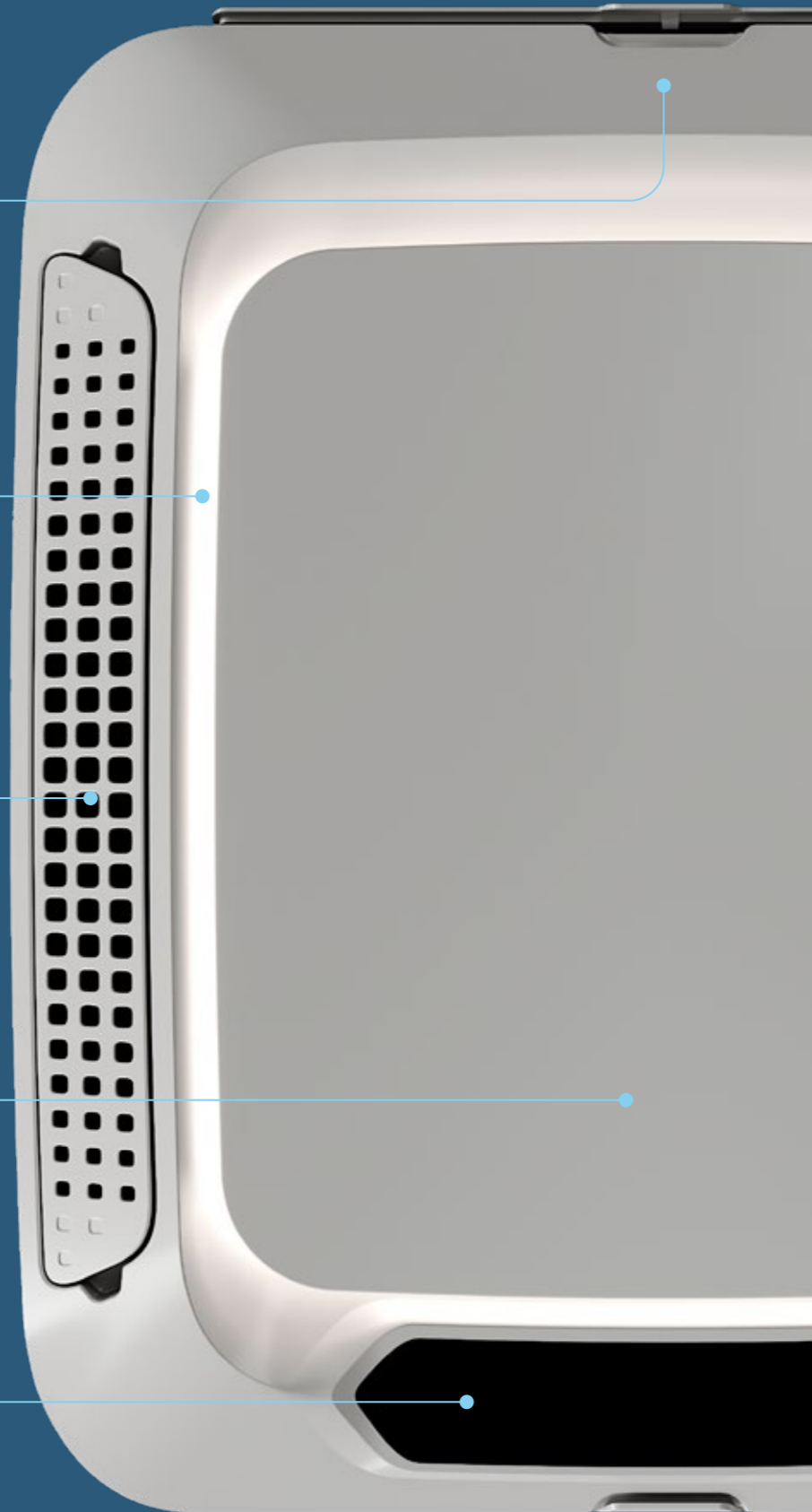

EN

The new Plein-Aircon 12V, redesigned and totally Made in Italy, achieves full efficiency and user-friendliness thanks to the new configuration of the fins. The precision and directional flexibility of the air is optimised, allowing distribution even vertically. RINGLIGHT features a customisable panel with a white or blue LED perimeter light. Customisation allows multiple finishes, fabrics and stickers to be applied to the surface of the panel, integrating the Plein-Aircon with the style of the vehicle's interiors.

IT

I nuovi Plein-Aircon 12V, rivisitati con un nuovo design e totalmente Made in Italy, raggiungono la piena efficienza e praticità grazie alla nuova configurazione delle alette. La precisione e la flessibilità direzionale dell'aria, infatti, è ottimizzata permettendo una distribuzione anche in verticale. RINGLIGHT è dotato di un pannello personalizzabile e con luce a LED perimetrale bianca o blu. La personalizzazione consente di applicare alla superficie del pannello molteplici finiture, tessuti e adesivi, integrando il Plein-Aircon allo stile degli interni del mezzo.

DE

Die neuen Plein-Aircon 12V, mit überarbeitetem Design und vollständig in Italien gefertigt, sind dank der neuen Konfiguration der Lüftungslamellen äußerst effizient und praktisch. Die Präzision und Flexibilität der Luftverteilung wurde optimiert, so dass auch eine vertikale Verteilung des Luftstroms möglich ist. RINGLIGHT verfügt über eine individuell gestaltbare Platte mit weißer oder blauer LED-Randbeleuchtung. Die Platte lässt sich in verschiedenen Ausführungen, Stoffen und Klebefolien individuell gestalten, um Plein-Aircon in den Stil des Wohnmobileninnerums zu integrieren.



NEW
PRODUCT
2024

Plein-Aircon 12V RINGLIGHT

- 246x670x800 mm
- 1200 Watt (max)
- 25,3 Kg
- DC 12V

PLEIN-AIRCON 12V
EXTERNAL UNIT



CUSTOMIZABLE PANEL

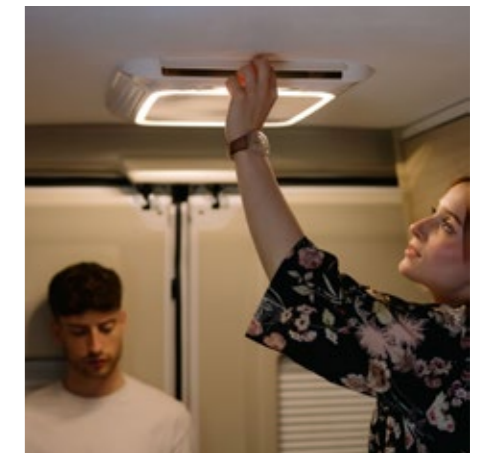
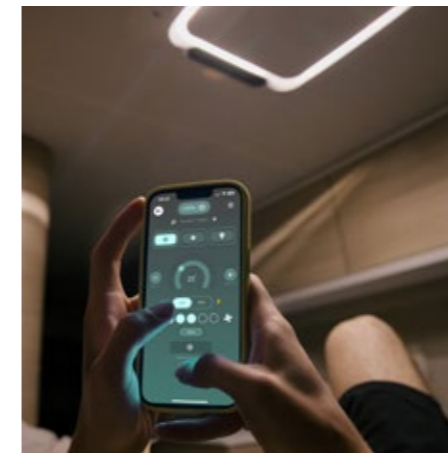

Plein-Aircon 12V LIGHTBOX

The feeling of a roof porthole



NEW AIRFLOW
TECHNOLOGY



ULTRA
SILENT



RADIANT
WHITE LIGHT



RADIANT
BLUE LIGHT



SMART
MAINTENANCE



6 SMART
MODE



TOUCH
DISPLAY



REMOTE
APP CONTROL

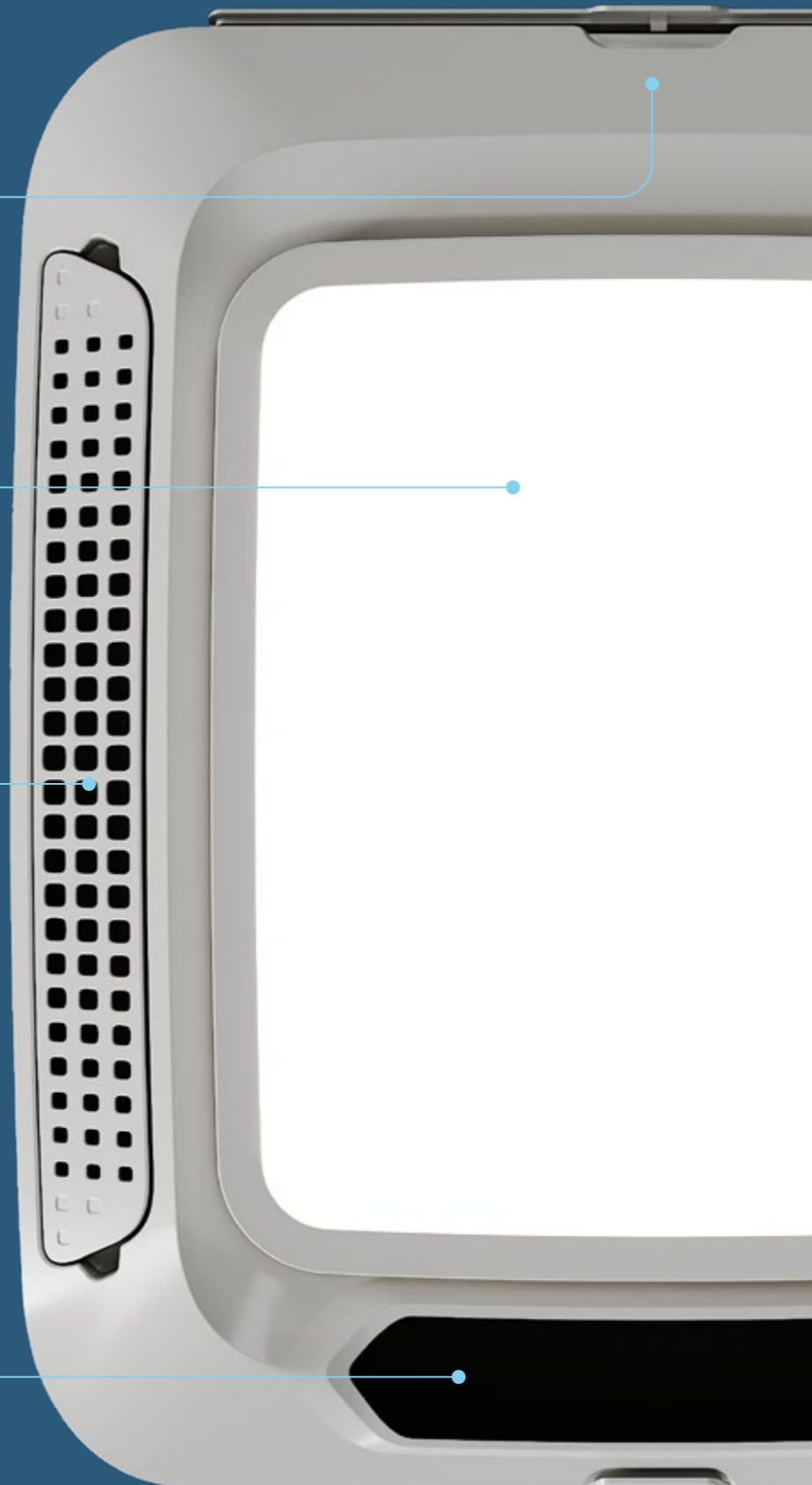

EN

The new Plein-Aircon 12V, redesigned and totally Made in Italy, achieves full efficiency and user-friendliness thanks to the new configuration of the fins. The precision and directional flexibility of the air is optimised, allowing distribution even vertically. LIGHTBOX, specially designed to return natural light from the porthole, radiates and diffuses white or blue light, the latter of which is ideal for night driving.

IT

I nuovi Plein-Aircon 12V, rivisitati con un nuovo design e totalmente Made in Italy, raggiungono la piena efficienza e praticità grazie alla nuova configurazione delle alette. La precisione e la flessibilità direzionale dell'aria, infatti, è ottimizzata permettendo una distribuzione anche in verticale. LIGHTBOX, appositamente progettato per restituire la luce naturale dell'oblò, irradia e diffonde una luce bianca o blu, quest'ultima ideale per la guida notturna.

DE

Die neuen Plein-Aircon 12V, mit überarbeitetem Design und vollständig in Italien gefertigt, sind dank der neuen Konfiguration der Lüftungslamellen äußerst effizient und praktisch. Die Präzision und Flexibilität der Luftverteilung wurde optimiert, so dass auch eine vertikale Verteilung des Luftstroms möglich ist. LIGHTBOX wurde speziell entwickelt, um den natürlichen Lichteinfall eines Dachfensters zu simulieren. Das weiße oder blaue Licht ist ideal für Nachtfahrten.



NEW
PRODUCT
2024

Plein-Aircon 12V LIGHTBOX

- 246x670x800 mm
- 1200 Watt (max)
- 25,3 Kg
- DC 12V



PLEIN-AIRCON 12V
EXTERNAL UNIT

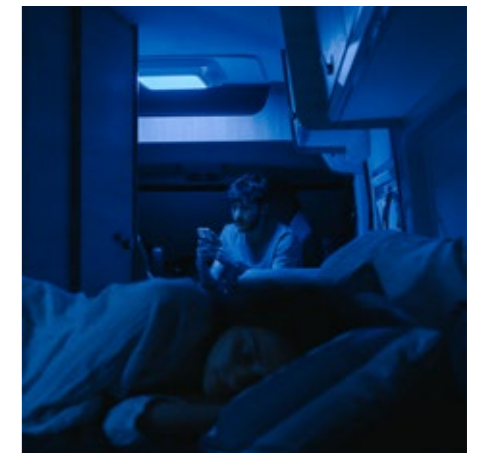



The further you go,
the more it will get you

EN

The greatest revolution of the new Plein-Aircon models lies in the functionality managed by an app with dual connectivity Bluetooth and Wi-Fi*. The app makes interaction with the product intelligent, simple and intuitive: in addition to the classic manual operation, Indel B's innovative **Pre-Adaptive technology** (Smart mode) adapts the operation of the air conditioner by learning from the user's habits and optimizes performance in relation to the weather conditions of the current location or by predicting those of a set future destination. In addition, with the app it is possible to receive information for diagnostics and service purposes.

* Functionality requires an already active Wi-Fi connection.
La funzionalità richiede una connessione Wi-Fi già attiva.
Funktionalität erfordert eine bereits aktive WLAN-Verbindung.

IT

La più grande rivoluzione dei nuovi Plein-Aircon sta nelle funzionalità gestite da un'app con doppia connettività Bluetooth e Wi-Fi*. L'app rende l'interazione con il prodotto intelligente, semplice e intuitiva: oltre al classico funzionamento manuale, l'innovativa **tecnologia Pre-Adaptive** di Indel B (modalità Smart) adatta il funzionamento del condizionatore apprendendo dalle abitudini dell'utilizzatore e ottimizza le prestazioni in relazione alle condizioni meteorologiche della località attuale oppure prevedendo quelle di una meta futura impostata. Inoltre, con l'app è possibile ricevere informazioni per diagnostica e assistenza.

DE

Die größte Revolution bei der neuen Plein-Aircon liegt in der über eine App mit doppelter Bluetooth- und WLAN-Konnektivität* gesteuerten Funktionalität. Die App macht die Interaktion mit dem Produkt intelligent, einfach und intuitiv. Neben der klassischen manuellen Bedienung sorgt die innovative **Pre-Adaptive-Technologie** (Smart-Modus) von Indel B dafür, dass sich der Betrieb des Klimageräts an die Gewohnheiten des Benutzers anpasst und die Leistung je nach Wetterlage am aktuellen Standort oder durch Vorhersage der Wetterlage an einem festgelegten Zielort optimiert wird. Mit der App können Sie zudem Informationen für Diagnose und Service erhalten.

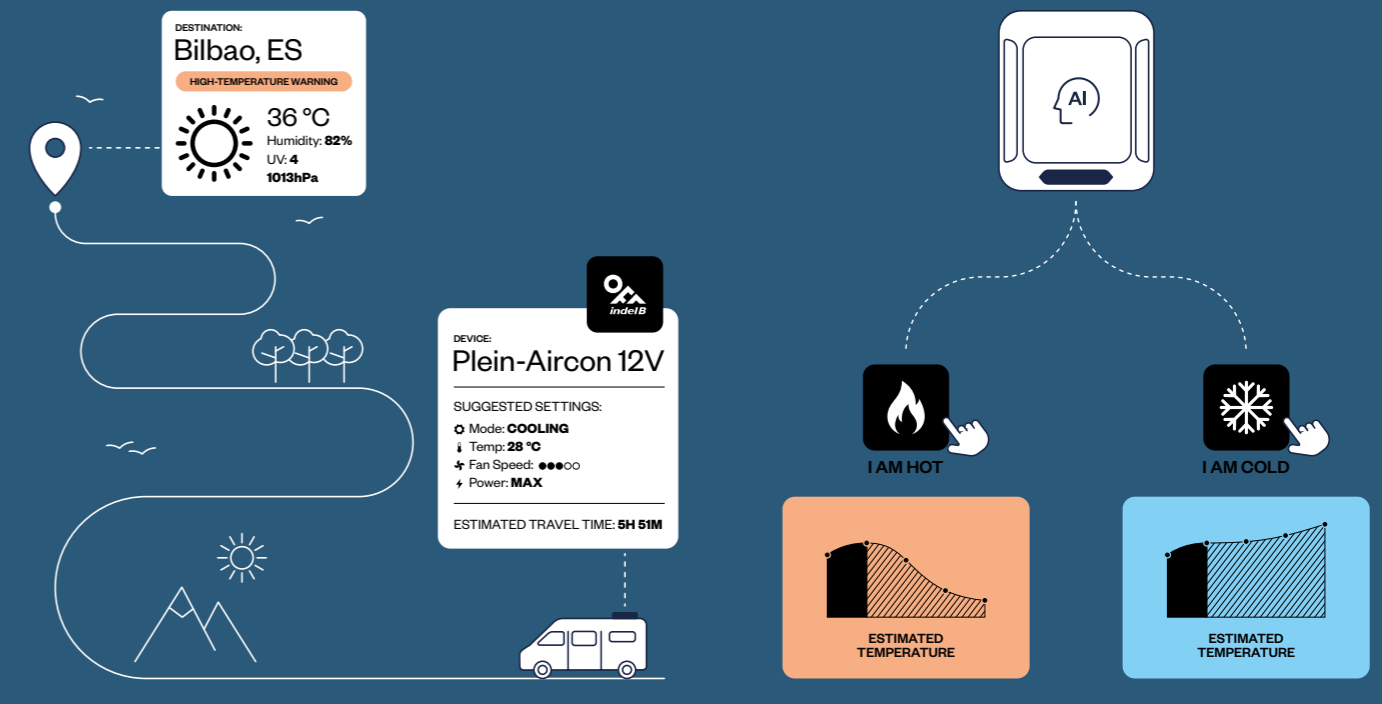

PREDICTIVE FUNCTION

ADAPTIVE FUNCTION



WI-FI REMOTE CONTROL

MANUAL SETUP

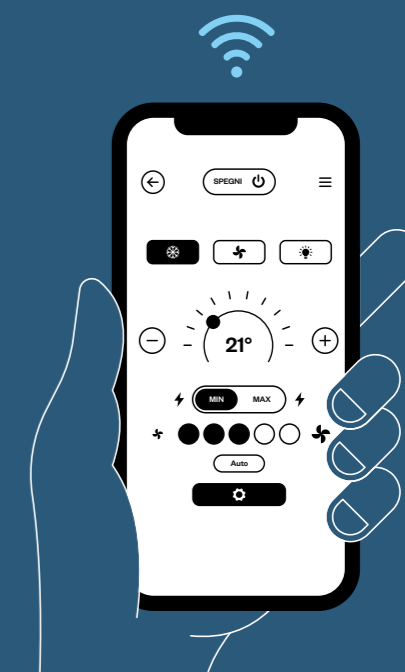
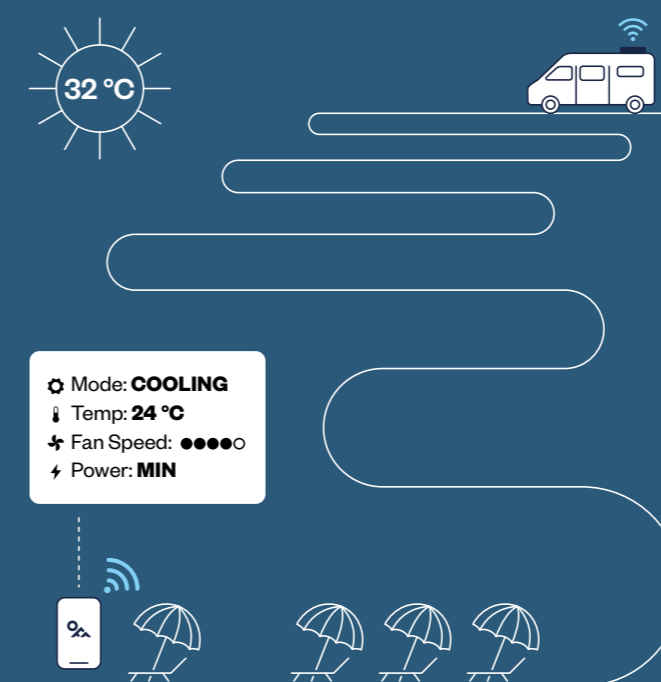

The image shows the interior of a car at night, bathed in a deep blue light. A person is seated in the driver's seat, looking down at a smartphone held in their hands. The car's interior features, such as the dashboard, steering wheel, and seats, are visible in silhouette against the blue glow. A rectangular light fixture is mounted on the ceiling. The overall atmosphere is calm and modern.

DRIVING IN BLUE. COMFORT ON THE ROAD

How to use



Camper Van



Motorhome

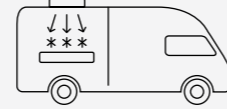

Best for bed area

EN

Plein-Aircon 12V cools and dehumidifies the sleeping area of any Motorhome.

IT

Plein-Aircon 12V raffredda e deumidifica la zona letto di qualsiasi Motorhome.

DE

Plein-Aircon 12V kühlt und entfeuchtet der Schlafbereich eines jeden Reisemobils.

Comparison



Plein-Aircon 12V RINGLIGHT



Plein-Aircon 12V LIGHTBOX

WHITE LIGHT	Perimetral	Radiant
NIGHT LIGHT	Perimetral	Radiant
TOUCH DISPLAY	Yes	Yes
DEVICE CONTROL	Touch Display / Smartphone	Touch Display / Smartphone
APP	Yes	Yes
BLUETOOTH / WI-FI	Yes	Yes
SMART MODES	Yes	Yes

Technical Data



	Plein-Aircon 12V RINGLIGHT	Plein-Aircon 12V LIGHTBOX
Compressor	12V Samsung	12V Samsung
Input voltage	12V DC (Optional 115V-230V Smart Switch Power Supply)	12V DC (Optional 115V-230V Smart Switch Power Supply)
Refrigerant gas	R134A	R134A
Cooling capacity	1200 W - 4100 BTU (max)	1200 W - 4100 BTU (max)
12V power consumption*	16 AMP/H (AUTO) 42 amp/h (max)	16 AMP/H (AUTO) 42 amp/h (max)
External unit dimensions (HxWxD)	246x670x800 mm	246x670x800 mm
Evaporating unit dimensions (HxWxD)	50x533x600 mm	50x533x600 mm
Roof cut-out dimensions (WxD)	400x400 mm	400x400 mm
Roof thickness	30-70 mm	30-70 mm
Weight	25,3 Kg	25,3 Kg
Air vents number	2 (front/rear)	2 (front/rear)
Blower speed number	5 + auto	5 + auto
Air flow	350 m ³ /h	350 m ³ /h
Timer	Yes	Yes
Battery protection	Yes	Yes
Starting current	Very low	Very low
Soft Start function	Yes	Yes
Suggested vehicle length	Up to 6 meters	Up to 6 meters
Interchangeable internal filters	Yes	Yes
Test marks	E-mark / EMC	E-mark / EMC
Eco Sustainable System	NO GENERATOR OR INVERTER NEEDED	NO GENERATOR OR INVERTER NEEDED

* at 32°C ambient temperature (internal and external)



Universal Easy Kit

Fixing kit for flat surfaces also suitable for corrugated roofs. This kit helps you position Plein-Aircon 12V correctly, adapting to the surface and preventing water filtration.

Kit di fissaggio ideato per superfici piane e utilizzabile anche per tetti corrugati. Il Kit permette di posizionare correttamente il Plein-Aircon 12V adattandosi perfettamente alla superficie, prevenendo i rischi di infiltrazione dell'acqua.

Der Befestigungsbausatz ist für flache Oberflächen konzipiert und kann auch für Wellblechdächer verwendet werden. Mit dem Bausatz kann der Plein-Aircon 12V richtig positioniert werden, so dass er sich perfekt an die Oberfläche anpasst und das Risiko des Eindringens von Wasser verhindert.

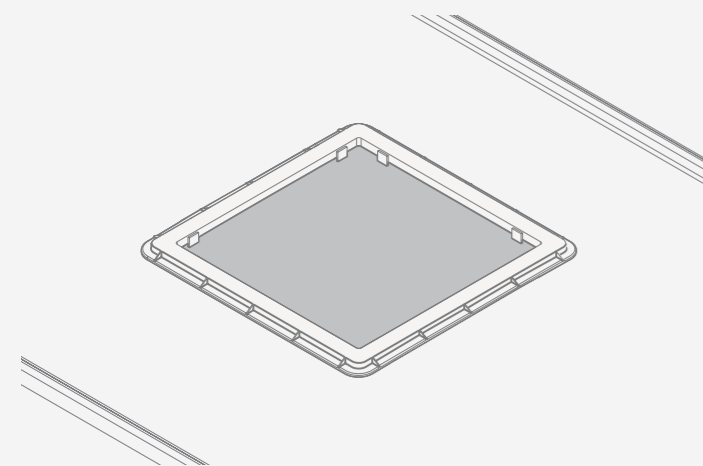

External dimensions	490x490
Internal dimensions	400x400
Installation	Silicone bonding

VW Crafter/MAN TGE Kit

Custom-designed adapter frame for installation on the Volkswagen Crafter and MAN TGE >Model Year 2017 slatted roof. The adapter frame allows you to correctly place the Plein-Aircon 12V adapting it to the surface, thus preventing the risks of water infiltration.

Kit progettato su misura per l'installazione sul tetto dogato dei Volkswagen Crafter e MAN TGE >Model Year 2017. Il kit permette di posizionare correttamente il Plein-Aircon 12V adattandosi perfettamente alla superficie, prevenendo così i rischi di infiltrazione dell'acqua.

Bausatz, der speziell für die Montage auf dem Lamellendach des Volkswagen Crafter und MAN TGE >Model Year 2017 entwickelt wurde. Mit dem Bausatz kann der Plein-Aircon 12V richtig positioniert werden, so dass er sich perfekt an die Oberfläche anpasst und somit das Risiko des Eindringens von Wasser verhindert.

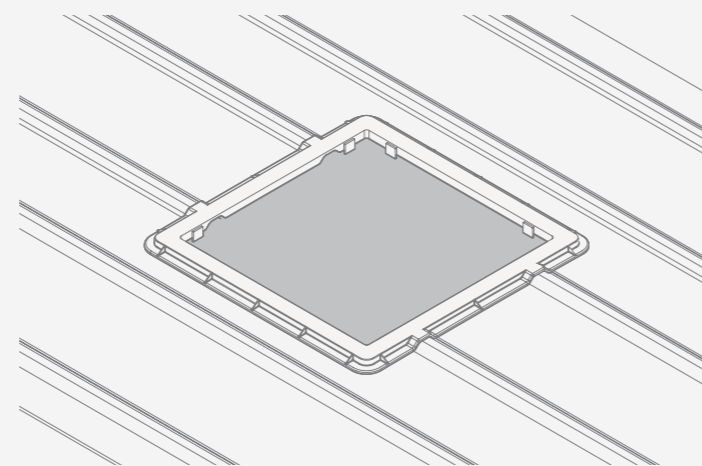

External dimensions	490x490
Internal dimensions	400x400
Installation	Silicone bonding

12V Plein-Aircon Protective Cover



Sleeping Well Cube 12V

sleeping
Well
cube



INNOVATIVE
12V
AIR CONDITIONING
SYSTEM



USABLE
IN MOTION

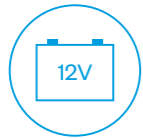

BATTERY
OPERATED

EN

Solid and light, SW Cube 12V is mainly made for small spaces as a tent, tent trailer, or small vans with a lifting roof.

It can be easily moved from one vehicle to another and doesn't require fixed installation as all traditional air conditioner systems. Thanks to the flexible air intake tubes it adapts quickly to all environments, providing a pleasant cool feeling and low power consumption.

IT

Compatto e leggero, SW Cube 12V è destinato principalmente ad ambienti piccoli come tenda, carrello tenda o piccoli van con lifting roof. Può essere facilmente spostato da un veicolo all'altro, e non necessita di alcuna installazione fissa come tutti i tradizionali impianti di aria condizionata. Grazie ai tubi di portata dell'aria flessibili si adatta facilmente a qualsiasi ambiente regalando una piacevole sensazione di fresco e bassi consumi.

DE

Der kompakte und leichte SW Cube 12V ist vor allem für kleine Räume wie Zelte, Zeltwagen oder Kleintransporter mit Hubdach gedacht. Er lässt sich leicht von einem Fahrzeug zu einem anderen bewegen und erfordert keine feste Installation wie alle herkömmlichen Klimaanlage. Dank der flexiblen Luftstromschläuche passt er sich leicht an jede Umgebung an und vermittelt ein angenehmes Gefühl von Kühle und geringem Verbrauch.

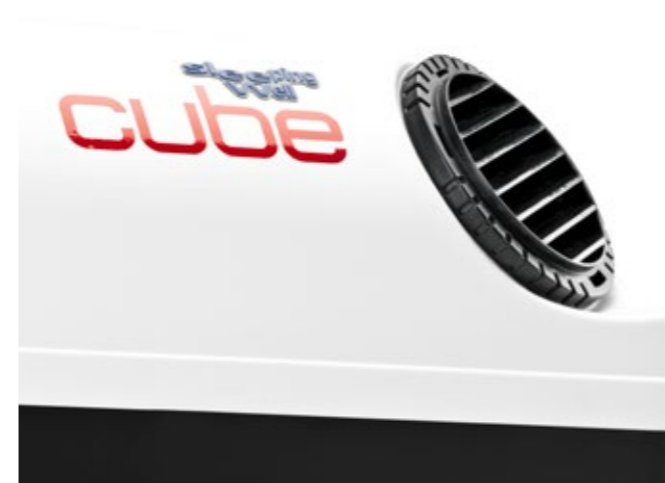

SLEEPING WELL CUBE 12V

EN

SW Cube 12V doesn't require particular installation: you attach the connector kit to the power cable and it is ready for use. The system is pre-loaded and made with the same high-quality components present in all Sleeping Well line products. SW Cube 12V also has an automatic mode to optimize the speed of the compressor and the fans, ensuring lower power consumption.

IT

SW Cube 12V non necessita di particolari installazioni, basta collegare il kit connettori al cavo di potenza ed è subito pronto all'uso. Il sistema è già precaricato e realizzato con gli stessi componenti di alta qualità presenti in tutta la linea di prodotti Sleeping Well. In modalità automatica SW Cube 12V ottimizza la velocità del compressore e delle ventole garantendo i più bassi consumi.

DE

SW Cube 12V benötigt keine besondere Installation, schließen Sie einfach den Steckersatz an das Stromkabel an und er ist sofort einsatzbereit. Das System ist bereits geladen und aus den gleichen hochwertigen Komponenten hergestellt, die in der gesamten Sleeping Well Produktlinie vorzufinden sind. Im Automatikbetrieb optimiert SW Cube 12V die Drehzahl des Kompressors und der Lüfter und sorgt so für geringsten Stromverbrauch.



Sleeping Well Cube 12V

- 400x360x370 mm
- 950 W (max)
- 19,5 Kg
- DC 12V



How to use



Tent

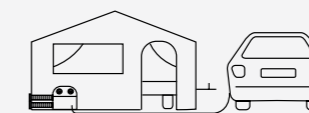

Tent trailers



Lifting roof

EN

SW Cube 12V is ideal for cooling tents or tent trailers by connecting the device to the 12V power source of the vehicle and facing the vents towards the outside.

IT

SW Cube 12V è ideale per il raffreddamento di tende da campeggio o carrelli tenda collegando il dispositivo all'alimentazione 12V dell'auto e disponendo le bocchette verso l'esterno.

DE

SW Cube 12V ist ideal für die Kühlung von Campingzelten oder Zeltwagen, indem das Gerät an die 12V-Stromversorgung des Autos angeschlossen und die Lüftungsöffnungen nach außen verlegt werden.

Technical Data

Compressor	12V Secop	Battery protection system	Yes
Voltage	12V DC	Dimensions (HxWxD)	400x360x370 mm
Refrigerant power	950 W - 3250 btu (max)	Weight of SW Cube unit	19,5 Kg
Consumption 12V	36 amp/h (max 12V)	Timer	Yes
Heating function	Yes	Weight	19,5 Kg + 2,8 Kg pack
Maximum ventilating power	6 speeds (450 m ³)	Packaging dimensions (HxWxD)	709x405x385 mm
Remote control	Yes	Feature	Portable unit



INSTALLATION REFRIGERATORS

FRIGORIFERI
DA INSTALLAZIONE

EINBAUKÜHLSCHRÄNKE

Slim	50
Cruise	56
Elite	64
Drawer	72
Top Loaded	80
Special	86

A complete range of products for all needs.

Indel B's OFF solutions for refrigeration present premium characteristics to ensure great flexibility during installation. The reversible door with low thickness profiles is perfect for integration respecting the inside design of the vehicle. As well with the automatic door closing system and a great versatility for the shelves and bins inside the refrigerators.

Noise and power consumption reduced. These are automotive certified, approved by European and North American truck manufacturers and installed successfully in millions of vehicles.

IT

Una gamma di prodotti completa studiata per ogni tipo di esigenza.

Le soluzioni OFF di Indel B per la refrigerazione hanno caratteristiche premium per garantire una grande flessibilità di installazione, come la porta reversibile con profili a basso spessore per permettere una elevata integrazione estetica del frigorifero con l'arredamento del veicolo, sistemi di bloccaggio automatico dello sportello e una grande versatilità di configurazione delle mensole e dei cestelli del vano interno.

Caratterizzati da una bassa rumorosità e limitati consumi energetici, sono certificati automotive e approvati in primo impianto dai costruttori di camion europei e nordamericani e montati con successo su diversi milioni di veicoli.

DE

Ein komplettes Sortiment von Produkten für jeden Bedarf.

Die Lösungen "OFF" von Indel B für die Kühlung verfügen über erstklassige Eigenschaften, die eine große Flexibilität bei der Installation garantieren, wie z.B. die umkehrbare Tür mit Profilen geringer Dicke, die eine hohe ästhetische Integration des Kühlschranks mit dem Fahrzeuginnenraum ermöglicht, automatische Türverriegelungssysteme und eine große Vielseitigkeit bei der Konfiguration von Fächern und Körben des Innenraums.

Sie zeichnen sich durch geringe Geräuschentwicklung und geringen Energieverbrauch aus, sind automobilzertifiziert und in der Erstausrüstung von europäischen und nordamerikanischen Lkw-Herstellern zugelassen und an mehreren Millionen Fahrzeugen erfolgreich montiert.

Products



Slim



Cruise



Elite



Drawer

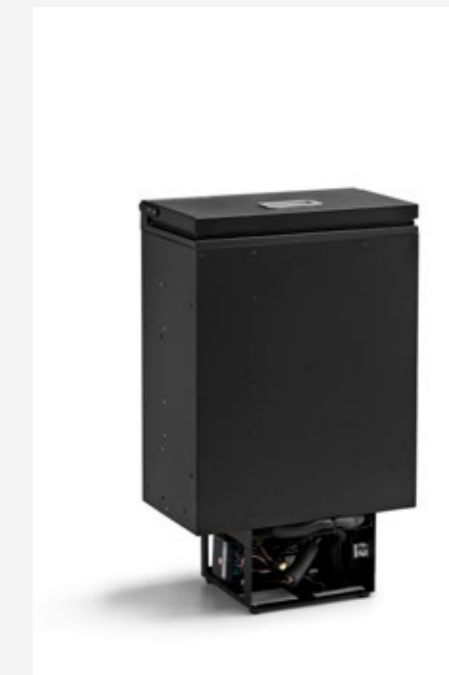

Top Loaded



Special

Slim

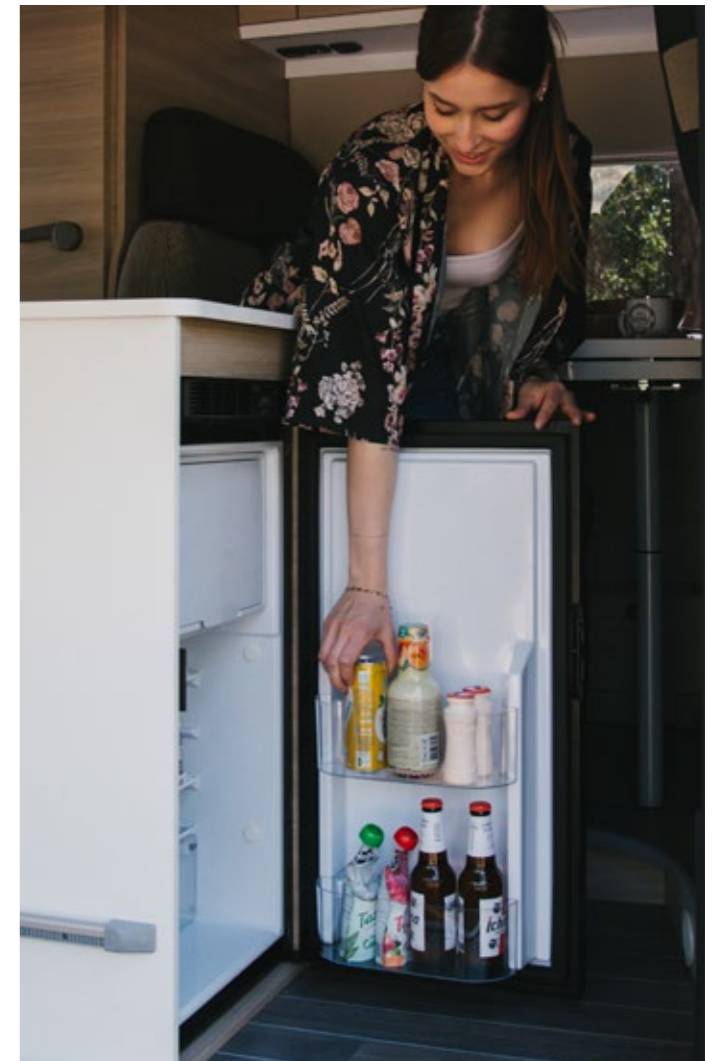

EN

The Slim range is designed to promote installation on vehicles with small interiors. Its vertical development allows for large internal space similar to a domestic refrigerator. Thanks to the Power Saving mode, you can optimise consumption during outdoor use, thus saving energy and preserving the battery. Moreover, the Silent Night function allows for greater acoustic comfort while maintaining high refrigeration performance.

IT

La linea Slim è stata attentamente studiata per favorire l'installazione su veicoli dagli spazi interni ridotti, lo sviluppo verticale consente infatti di mantenere una generosa capienza interna paragonabile a un frigorifero domestico. Grazie alla modalità Power Saving è possibile ottimizzare i consumi durante l'uso in plein-air con un significativo risparmio energetico preservando la durata della batteria. Una comoda funzione Silent Night permette inoltre di godere di un maggiore comfort acustico mantenendo comunque un'alta performance di refrigerazione.

DE

Die Slim-Linie wurde sorgfältig entworfen, um den Einbau in Fahrzeuge mit geringem Innenraum zu erleichtern. Die vertikale Entwicklung ermöglicht es, ein großzügiges Innenvolumen zu erhalten, das mit dem eines Haushaltskühlschranks vergleichbar ist. Dank des Energiesparmodus ist es möglich, den Verbrauch bei der Verwendung im Freien zu optimieren und so erhebliche Energieeinsparungen bei gleichzeitiger Schonung der Akkulaufzeit zu erzielen. Mit der praktischen Silent Night-Funktion können Sie außerdem einen höheren akustischen Komfort genießen und gleichzeitig eine hohe Kühlleistung beibehalten.



SLIM 70/90/140

EN

The Slim range is available in three models with a 70 or 140-litre capacity. All refrigerators are fitted with a LED display with Power Saving and Silent Night modes, customised door panel with reversible opening, and a handle with a lock for ensuring ventilation when the fridge is off.



SLIM 70

- 70 L
- 822x420x469 mm
- 20 kg + 2,5 Kg pack
- DC 12/24V
- Power 38 W

IT

La linea Slim è disponibile in tre modelli con capacità da 70 a 140 litri. Tutti i frigo sono dotati di display LED con modalità Power Saving e Silent Night, pannello porta personalizzabile con apertura reversibile e maniglia dotata di blocco per la ventilazione a frigo spento.



SLIM 90

- 90 L
- 976x420x504 mm
- 22,5 Kg + 3 Kg pack
- DC 12/24V
- Power 38 W

DE

Die Slim-Linie ist in drei Modellen mit einem Fassungsvermögen von 70 bis 140 Litern erhältlich. Alle Kühlschränke sind mit einem LED-Display mit Energiespar- und Silent Night-Modus, einer individuell gestaltbaren Türblende mit reversibler Öffnung und einem Griff mit Lüftungssperre bei ausgeschaltetem Kühlschrank ausgestattet.



SLIM 140

- 140 L
- 1454x420x540 mm
- 38 kg + 3,5 Kg pack
- DC 12/24V
- Power 70 W



Easy Fix



EN

The Easy Fix system allows a simpler and faster built-in installation than the traditional system. The installation takes place by inserting fixing screws directly from inside the product to the walls of the cabinet through guide holes that prevent the refrigerator side insulation from breaking. The Easy Fix system also eliminates the need to apply mounting brackets.



IT

Il sistema Easy Fix consente un'installazione ad incasso più semplice e veloce rispetto al sistema tradizionale. L'installazione avviene tramite l'inserimento di viti di fissaggio direttamente dall'interno del prodotto alle pareti del mobile tramite dei fori guida passanti che impediscono la rottura dell'isolante laterale del frigorifero. Il sistema Easy Fix elimina anche la necessità di applicazione delle flange di copertura.

DE

Das Easy Fix-System ermöglicht eine einfachere und schnellere Einbau-Installation als das herkömmliche System. Für den Einbau werden Befestigungsschrauben direkt von der Innenseite des Produkts an den Schrankwänden durch Führungslöcher befestigt, damit die seitliche Isolierung des Kühlschranks nicht beschädigt wird. Durch das Easy Fix-System entfällt auch die Notwendigkeit von Montagerahmen.



Name	Gross Volume	Freezer Volume	External dim. (HxWxD) mm	Weight	Installed power	Climate Class	Consumption 12-24V	Voltage	Certifications	Compressor	Internal light
SLIM 70	70 L	12 L	822x420x469	20 Kg 2,5 Kg pack	38 W	T	0,290 kWh/24h	DC 12/24V	CE EMC E-Mark	SECOP BDN50K	●
SLIM 90	90 L	11 L	976x420x504	22,5 Kg 3 Kg pack	38 W	T	0,340 kWh/24h	DC 12/24V	CE EMC E-Mark	SECOP BDN50K	●
SLIM 140	140 L	17 L	1454x420x540	38 Kg 3,5 Kg pack	70 W	ST	0,450 kWh/24h	DC 12/24V	CE EMC E-Mark	SECOP BD80CN	●

EN

All refrigerators are rated according to the maximum and minimum ambient temperatures they can function in. The climatic classes assigned to refrigerators and freezers serve to ensure their perfect functioning in the environment in which they are located.

ST: Sub Tropical
Operation at room temperature from +16 °C to +38 °C
T: Tropical
Operation at room temperature from +16 °C to +43 °C

IT

Tutti i frigoriferi sono classificati in base alle temperature ambiente massime e minime in cui possono funzionare. Le classi climatiche assegnate ai frigoriferi e ai congelatori servono a garantirne il perfetto funzionamento nell'ambiente in cui si trovano.

ST: Subtropicale
Funzionamento a temperatura ambiente da +16 °C a +38 °C
T: Tropicale
Funzionamento a temperatura ambiente da +16 °C a +43 °C

DE

Alle Kühl- und Gefriergeräte werden nach der maximalen und minimalen Umgebungstemperatur, bei der sie betrieben werden können, klassifiziert. Die den Kühl- und Gefriergeräten zugeordneten Klimaklassen sollen den störungsfreien Betrieb in dem jeweiligen Aufstellungsraum sicherstellen.

ST: Subtropisch
Betrieb bei einer Umgebungstemperatur von +16 °C bis +38 °C
T: Tropisch
Betrieb bei einer Umgebungstemperatur von +16 °C bis +43 °C

Cruise



EN

Cruise Indel B refrigerators are true compressor refrigerators with high performance comparable to the fridge in your home. Cruise fridges are designed for safe food temperature storage while you travel. The Cruise range (CR100 excluded) is equipped with the Easy Fix rapid installation mounting system. A new-look contemporary designed handle is both functional and practical with as well new inox internal details. The energy aspect has also been improved thanks to the optimization of the refrigeration system to reduce consumption, while maintaining high and constant operating performance.

IT

I Cruise Indel B sono dei veri e propri frigoriferi dalle elevate prestazioni paragonabili ai frigoriferi domestici, indispensabili per conservare tutti gli alimenti in modo corretto alla giusta temperatura senza dover ricorrere alla spesa quotidiana di prodotti freschi. La gamma Cruise (CR100 escluso) è dotata di sistema Easy Fix per un'installazione rapida e semplificata, con una maniglia dal nuovo design ancora più pratica, funzionale e dal look contemporaneo e dall'inserimento di dettagli interni in inox. Anche l'aspetto energetico è stato perfezionato grazie all'ottimizzazione del sistema di refrigerazione per abbattere i consumi, mantenendo elevate e costanti le performance di esercizio.

DE

Bei den Kühlschränkenw Cruise von Indel B handelt es sich um echte Hochleistungskühlschränke, die mit Haushaltskühlschränken vergleichbar sind. Sie sind unverzichtbar, wenn es darum geht, Lebensmittel bei der richtigen Temperatur zu lagern, ohne täglich frische Produkte einkaufen zu müssen. Die Serie Cruise (ausgenommen CR100) ist mit dem Easy Fix-System für eine schnelle und einfache Installation sowie mit einem noch praktischeren, funktionelleren und zeitgemäßen Griffdesign ausgestattet und verfügt über eine Innenausstattung aus Edelstahl. Der Energieverbrauch wurde dank der Optimierung des Kühlsystems ebenfalls verbessert, um den Verbrauch zu senken und gleichzeitig eine hohe und konstante Betriebsleistung zu gewährleisten.

CRUISE 42 / 49

EN

The smallest built-in compressor refrigerators for caravan and motorhome. Both equipped with freezer compartment, they're different in volume and depth. All 2 models can store bottles both in vertical and horizontal position.

IT

I più piccoli frigoriferi a compressore ad incasso per installazioni fisse a bordo di camper e caravan. Entrambi dotati di comparto freezer, si differenziano tra loro per volume e profondità. I due modelli possono contenere bottiglie in verticale e in orizzontale.

DE

Die kleinsten Kompressorkühlschränke zur Festinstallation an Bord von Reisemobilen oder Caravans. Beide mit Gefrierfach ausgestattet, unterscheiden sie sich in Volumen und Tiefe. In den zwei Modellen können Flaschen vertikal und horizontal gelagert werden.



CR42

- 42 L
- 530x380x355 mm
- 14,5 Kg + 2,5 Kg pack
- DC 12/24V
- Power 40 W

CR49

- 49 L
- 530x380x(345+145)* mm
- 16,5 Kg + 2 Kg pack
- DC 12-24V
- Power 45 W



(*) Remote compressor

CRUISE 65 / 85 / 86



EN

Medium-size refrigerators with a rational design to fully use all the volume available. With its vertical installation, the CR86 was made for the most critical spaces, in line with the new trends of design of all vehicles. Thanks to the different compartments on multiple levels it ensures a standard volume.

IT

Frigoriferi di medie dimensioni dal design razionale che permette un totale sfruttamento del volume contenitivo a disposizione. Inoltre il CR86, con il suo sviluppo verticale, è stato studiato per sfruttare gli spazi interni più stretti in linea con le nuove tendenze di design dei differenti veicoli. Prevedendo diversi vani interni su più piani garantisce comunque una volumetria standard.

DE

Kühlschränke mittlerer Größe mit einem zweckmäßigen Design, die eine vollständige Ausnutzung des verfügbaren Lagervolumens ermöglichen. Darüber hinaus wurde der CR86 mit seiner vertikalen Entwicklung so konzipiert, dass die engsten Innenräume, in Übereinstimmung mit den neuen Designrends der verschiedenen Fahrzeuge, bestens genutzt werden können. Er sieht verschiedene Innenfächer auf verschiedenen Ebenen vor und garantiert ein einheitliches Volumen.



CR65

- 65 L
- 535x450x511 mm
- 17,5 Kg + 2,4 Kg pack
- DC 12/24V
- Power 60 W

CR85

- 85 L
- 635x475x545 mm
- 21,5 Kg + 2,5 Kg pack
- DC 12/24V
- Power 60 W

CR86 SUPERSLIM

- 85 L
- 862x380x511 mm
- 23 Kg + 3 Kg pack
- DC 12/24V
- Power 50 W



CRUISE 100 / 130

EN

These are the most capacious refrigerators in their category; they are designed for long hauls. 1,5 litres bottles can be stored either in the door balconies or inside the cabinet thanks to the adaptable shelves.

IT

Progettati per lunghi viaggi, sono i frigoriferi più capienti della categoria, e permettono di contenere anche bottiglie fino a 1,5 litri sia sul balconcino che all'interno, attraverso le pratiche griglie adattabili.

DE

Entwickelt für lange Reisen, sind diese Kühlschränke die geräumigsten ihrer Klasse. Sie erlauben dem Benutzer Flaschen bis zu 1,5 Liter sowohl in den Türregalen wie auch im Inneren zu lagern, dies wird durch die praktischen verstellbaren Gitter ermöglicht.



CR100

- 100 L
- 745x485x500 mm
- 22,5 Kg + 2,5 Kg pack
- DC 12/24V
- Power 60 W

CR130

- 130 L
- 755x525x550 mm
- 25,5 Kg + 2,5 Kg pack
- DC 12/24V
- Power 60 W



Easy Fix



EN







The Easy Fix system allows a simpler and faster built-in installation than the traditional system. The installation takes place by inserting fixing screws directly from inside the product to the walls of the cabinet through guide holes that prevent the refrigerator side insulation from breaking. The Easy Fix system also eliminates the need to apply mounting brackets. Not available for CR100.

IT

Il sistema Easy Fix consente un'installazione ad incasso più semplice e veloce rispetto al sistema tradizionale. L'installazione avviene tramite l'inserimento di viti di fissaggio direttamente dall'interno del prodotto alle pareti del mobile tramite dei fori guida passanti che impediscono la rottura dell'isolante laterale del frigorifero. Il sistema Easy Fix elimina anche la necessità di applicazione delle flange di copertura. Non disponibile per il CR100.

DE

Das Easy Fix-System ermöglicht eine einfachere und schnellere Einbau-Installation als das herkömmliche System. Für den Einbau werden Befestigungsschrauben direkt von der Innenseite des Produkts an den Schrankwänden durch Führungslöcher befestigt, damit die seitliche Isolierung des Kühlschranks nicht beschädigt wird. Durch das Easy Fix-System entfällt auch die Notwendigkeit von Montagerahmen. Nicht verfügbar für CR100.

Name	Gross Volume	Freezer Volume	External dim. (HxWxD) mm	Weight	Installed power	Climate Class	Consumption 12-24V	Voltage	Certifications	Compressor	Internal light
 CR42	42 L	5 L	530x380x(345+145)* (* Remote compressor)	14,5 Kg 2,5 Kg pack	40 W	ST	0,300 kWh/24h	DC 12/24V	CE EMC E-Mark	SECOP BD1.4F FSD	
 CR49	49 L	5 L	530x380x495	16,5 Kg 2 Kg pack	45 W	ST	0,278 kWh/24h	DC 12/24V	CE EMC E-Mark	SECOP BD35F	•
 CR65	65 L	5 L	535x450x511	17,5 Kg 2,4 Kg pack	60 W	ST	0,288 kWh/24h	DC 12/24V	CE EMC E-Mark	SECOP BD35F	•
 CR85	85 L	8 L	635x475x545	21,5 Kg 2,5 Kg pack	60 W	ST	0,386 kWh/24h	DC 12/24V	CE EMC E-Mark	SECOP BD35F	•
 CR86 SUPERSLIM	85 L	10 L	862x380x511	23 Kg 3 Kg pack	50 W	ST	0,525 kWh/24h	DC 12/24V	CE EMC E-Mark	SECOP BD1.4 VSD-HD	•
 CR100	100 L	6 L	745x485x500	22,5 Kg 2,5 Kg pack	60 W	ST	0,400 kWh/24h	DC 12/24V	CE EMC E-Mark	SECOP BD35F	
 CR130	130 L	8 L	755x525x550	25,5 Kg 2,5 Kg pack	60 W	ST	0,438 kWh/24h	DC 12/24V	CE EMC E-Mark	SECOP BD35F	•

EN

All refrigerators are rated according to the maximum and minimum ambient temperatures they can function in. The climatic classes assigned to refrigerators and freezers serve to ensure their perfect functioning in the environment in which they are located.

ST: Sub Tropical
Operation at room temperature from +16 °C to +38 °C
T: Tropical
Operation at room temperature from +16 °C to +43 °C

IT

Tutti i frigoriferi sono classificati in base alle temperature ambiente massime e minime in cui possono funzionare. Le classi climatiche assegnate ai frigoriferi e ai congelatori servono a garantirne il perfetto funzionamento nell'ambiente in cui si trovano.

ST: Subtropicale
Funzionamento a temperatura ambiente da +16 °C a +38 °C
T: Tropicale
Funzionamento a temperatura ambiente da +16 °C a +43 °C

DE

Alle Kühl- und Gefriergeräte werden nach der maximalen und minimalen Umgebungstemperatur, bei der sie betrieben werden können, klassifiziert. Die den Kühl- und Gefriergeräten zugeordneten Klimaklassen sollen den störungsfreien Betrieb in dem jeweiligen Aufstellungsraum sicherstellen.

ST: Subtropisch
Betrieb bei einer Umgebungstemperatur von +16 °C bis +38 °C
T: Tropisch
Betrieb bei einer Umgebungstemperatur von +16 °C bis +43 °C



EN

Elite is the stylishly refined line of compressor refrigerators ideal for built-in installations where fashion as well as functionality counts. Elite's elegantly styled door has a stainless steel effect with a practical anti-touch finish. The minimalistically designed flush mounted door handle will compliment your sleek contoured van cabinetry and save space. Added to the style is our quietly operating high energy efficiency SECOP compressor that guarantees performance comparable to domestic refrigerators. Elite also comes equipped with the new "Easy Fix" system for quick and easy built-in installation.

IT

Elite è la linea di frigoriferi a compressore dal design raffinato e rappresenta la soluzione ideale per installazioni a incasso con frontale a vista. Lo stile Elite curato in ogni dettaglio vi conquisterà con l'elegante porta effetto acciaio inox con finitura anti-touch, la maniglia a filo dal design minimal e una vasta gamma di accessori per configurare al meglio lo spazio interno con grande flessibilità. Condivide con la linea Cruise la famiglia di compressori SECOP ad alta efficienza energetica che garantiscono prestazioni paragonabili ai frigoriferi domestici, grande silenziosità per un comfort in ogni situazione e il sistema Easy Fix per un'installazione a incasso semplice e veloce.

DE

Elite ist die Linie von Kompressor-Kühlschränken mit einem raffinierten Design und stellt die ideale Lösung für Einbauten mit Sichtfront dar. Der Elite-Stil mit seiner Liebe zum Detail überzeugt durch die elegante Tür in Edelstahlausführung mit einer speziellen Beschichtung zur Verhinderung von unschönen Fingerabdrücken, den flächenbündigen Griff mit minimalem Design und eine große Auswahl an Zubehör, um den Innenraum flexibel zu gestalten. Wie alle Fahrzeuge der Baureihe Cruise verfügt Elite über einen energieeffizienten SECOP-Kompressor, der eine mit Haushaltskühlschränken vergleichbare Leistung, Geräuschlosigkeit für absoluten Komfort in allen Situationen und das Easy Fix-System für einen schnellen und einfachen Einbau bietet.



ELITE 42 / 49

EN

Elite 42/49 are big solutions for small spaces. These models are the smallest built-in compressor refrigerators for van life. Despite their compact size, they are all equipped with a freezer compartment and can hold bottles both vertically and horizontally. The stainless steel effect door treated with a special anti-touch finish makes cleaning easy.

IT

Alleati dei piccoli spazi, Elite 42/49 sono i più piccoli frigoriferi a compressore ad incasso per camper e caravan. Nonostante le dimensioni compatte sono tutti dotati di comparto freezer e possono contenere bottiglie sia in verticale che in orizzontale. La porta effetto acciaio inossidabile trattata con una finitura speciale anti impronta semplifica le pulizie di routine.

DE

Elite 42/49 sind die kleinsten Kompressor-Einbaukühlschränke für Wohnwagen und Wohnmobile, die sich für kleine Räume eignen. Trotz ihrer kompakten Größe verfügen sie alle über ein Gefrierfach und können Flaschen entweder senkrecht oder waagrecht aufnehmen. Die Tür in Edelstahlausführung mit spezieller Beschichtung zur Verhinderung von Fingerabdrücken ist besonders pflegeleicht.



EL42

- 42 L
- 530x380x(345+145)* mm
- 14,5 Kg + 2,5 Kg pack
- DC 12/24V
- Power 42 W



EL49

- 49 L
- 530x380x531 mm
- 16,5 Kg + 2 Kg pack
- DC 12/24V
- Power 60 W



(*) Remote compressor

ELITE 65 / 85 / 86

EN

Elite 65/85/86 have generous capacity and flexible storage options that cope with a wide range of container shapes and sizes. Thanks to the repositionable shelves and the supplied accessories, the interior can be configured with great flexibility to make the most of the space. With its vertical installation, the new EL86 was made for the most critical spaces, in line with the new trends of design of all vehicles.

IT

Le dimensioni intermedie di EL 65/85/86 hanno un'ottima capienza che si adatta bene ai formati standard internazionali di bevande e confezioni. Grazie ai ripiani riposizionabili e agli accessori in dotazione, l'interno è configurabile con grande flessibilità per sfruttare al massimo lo spazio. Il nuovo EL86, con il suo sviluppo verticale, è stato studiato per sfruttare gli spazi interni più stretti in linea con le nuove tendenze di design dei differenti veicoli.

DE

Die Zwischenformate des Modells EL 65/85/86 weisen ebenfalls ein sehr gutes Fassungsvermögen auf, das auf die internationalen Standardverpackungen von Getränken und Lebensmitteln zugeschnitten ist. Dank der verschiebbaren Einlegeböden und des mitgelieferten Zubehörs lässt sich der Innenraum flexibel konfigurieren, um den Platz optimal zu nutzen. Darüber hinaus wurde der neue EL86 mit seiner vertikalen Entwicklung so konzipiert, dass die engsten Innenräume, in Übereinstimmung mit den neuen Designrends der verschiedenen Fahrzeuge, bestens genutzt werden können.



EL65

- 65 L
- 535x450x518 mm
- 17,5 Kg + 2,4 Kg pack
- DC 12/24V
- Power 60 W



EL85

- 85 L
- 635x475x552 mm
- 21,5 Kg + 2,5 Kg pack
- DC 12/24V
- Power 60 W



EL86 SUPERSLIM

- 85 L
- 862x380x522 mm
- 23 Kg + 3 Kg pack
- DC 12/24V
- Power 45 W

NEW
PRODUCT
2024



ELITE 130

EN

Elite 130 is large inside but stylishly compact outside designed to give you many flexible refrigeration storage capacity and configuration options. Our largest model has repositionable shelves and can hold 1.5 liters both on the balcony shelf or inside. Spend less time re-stocking and more time enjoying your van life adventures thanks to the generous removable storage drawers for fruits/vegetables.



EL130

- 130 L
- 755x525x557 mm
- 25,5 Kg + 2,5 Kg pack
- DC 12/24V
- Power 60 W





IT

Il frigorifero a compressore più capiente della linea Elite è la massima espressione della tecnologia Indel B per chi non vuole rinunciare al comfort in viaggio e aggiungere un tocco di stile all'interno del proprio camper. Grande dentro e compatto fuori, Elite 130 è progettato per offrire massima flessibilità nell'organizzazione dello spazio interno, grazie ai ripiani riposizionabili, contenere bottiglie fino a 1,5 litri sia sul balconcino che all'interno e conservare frutta e verdura nell'apposito cassetto estraibile.

DE

Der größte Kompressor-Kühlschrank der Elite-Linie ist der ultimative Ausdruck der Indel B-Technologie für alle, die auch auf Reisen nicht auf Komfort verzichten und dem Innenraum ihres Reisemobils einen Hauch von Stil verleihen möchten. Der Elite 130 - innen geräumig und außen kompakt -, bietet dank der verschiebbaren Einlegeböden maximale Flexibilität bei der Organisation des Innenraums. Bis zu 1,5-l-größe Flaschen finden entweder in der Türablage oder im Innenraum Platz, während Obst und Gemüse bestens in den Schubladen aufbewahrt werden kann.



	Name	Gross Volume	Freezer Volume	External dim. (HxWxD) mm	Weight	Installed power	Climate Class	Consumption 12-24V	Voltage	Certifications	Compressor	Internal light
	EL42	42 L	5 L	530x380x(345+145)* (* Remote compressor)	14,5 Kg 2,5 Kg pack	42 W	ST	0,285 kWh/24h	DC 12/24V	CE EMC E-Mark	SECOP BD1.4F AM	
	EL49	49 L	5 L	530x380x531	16,5 Kg 2 Kg pack	60 W	ST	0,265 kWh/24h	DC 12/24V	CE EMC E-Mark	SECOP BD35F	•
	EL65	65 L	5 L	535x450x518	17,5 Kg 2,4 Kg pack	60 W	ST	0,275 kWh/24h	DC 12/24V	CE EMC E-Mark	SECOP BD35F	•
	EL85	85 L	8 L	635x475x552	21,5 Kg 2,5 Kg pack	60 W	ST	0,368 kWh/24h	DC 12/24V	CE EMC E-Mark	SECOP BD35F	•
	EL86 SUPERSLIM	85 L	10 L	862x380x522	23 Kg 3 Kg pack	45 W	ST	0,500 kWh/24h	DC 12/24V	CE EMC E-Mark	SECOP BD1.4F HD MICRO	•
	EL130	130 L	8 L	755x525x557	25,5 Kg 2,5 Kg pack	60 W	ST	0,418 kWh/24h	DC 12/24V	CE EMC E-Mark	SECOP BD35F	•

EN

All refrigerators are rated according to the maximum and minimum ambient temperatures they can function in. The climatic classes assigned to refrigerators and freezers serve to ensure their perfect functioning in the environment in which they are located.

ST: Sub Tropical
Operation at room temperature from +16 °C to +38 °C
T: Tropical
Operation at room temperature from +16 °C to +43 °C

IT

Tutti i frigoriferi sono classificati in base alle temperature ambiente massime e minime in cui possono funzionare. Le classi climatiche assegnate ai frigoriferi e ai congelatori servono a garantirne il perfetto funzionamento nell'ambiente in cui si trovano.

ST: Subtropicale
Funzionamento a temperatura ambiente da +16 °C a +38 °C
T: Tropicale
Funzionamento a temperatura ambiente da +16 °C a +43 °C

DE

Alle Kühl- und Gefriergeräte werden nach der maximalen und minimalen Umgebungstemperatur, bei der sie betrieben werden können, klassifiziert. Die den Kühl- und Gefriergeräten zugeordneten Klimaklassen sollen den störungsfreien Betrieb in dem jeweiligen Aufstellungsraum sicherstellen.

ST: Subtropisch
Betrieb bei einer Umgebungstemperatur von +16 °C bis +38 °C
T: Tropisch
Betrieb bei einer Umgebungstemperatur von +16 °C bis +43 °C

Drawer

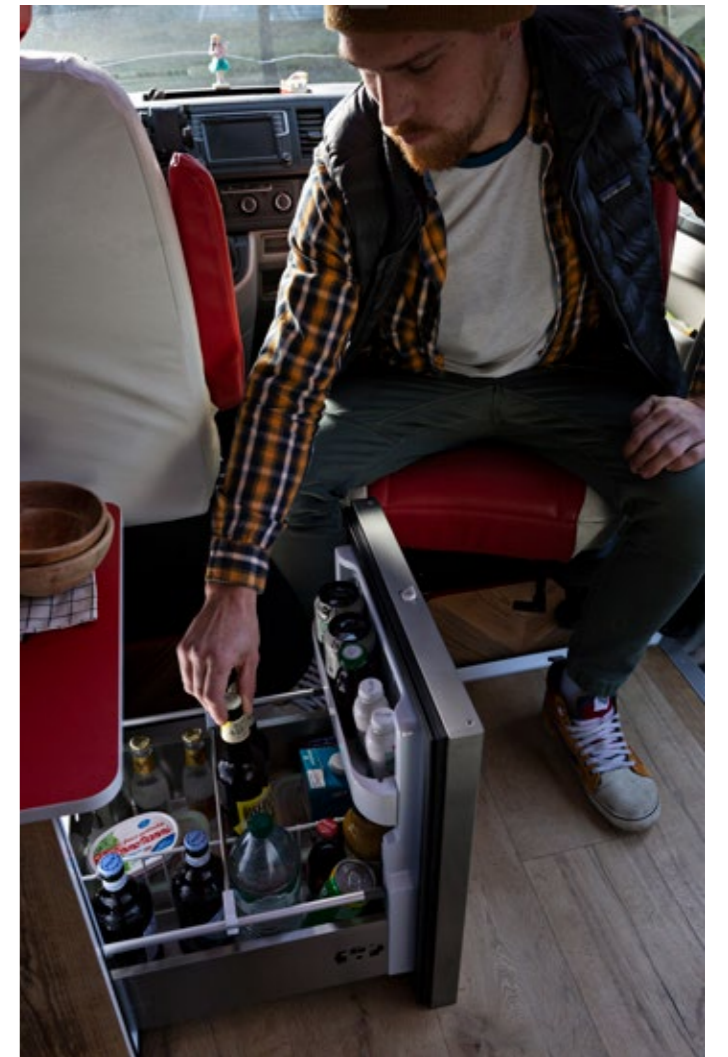
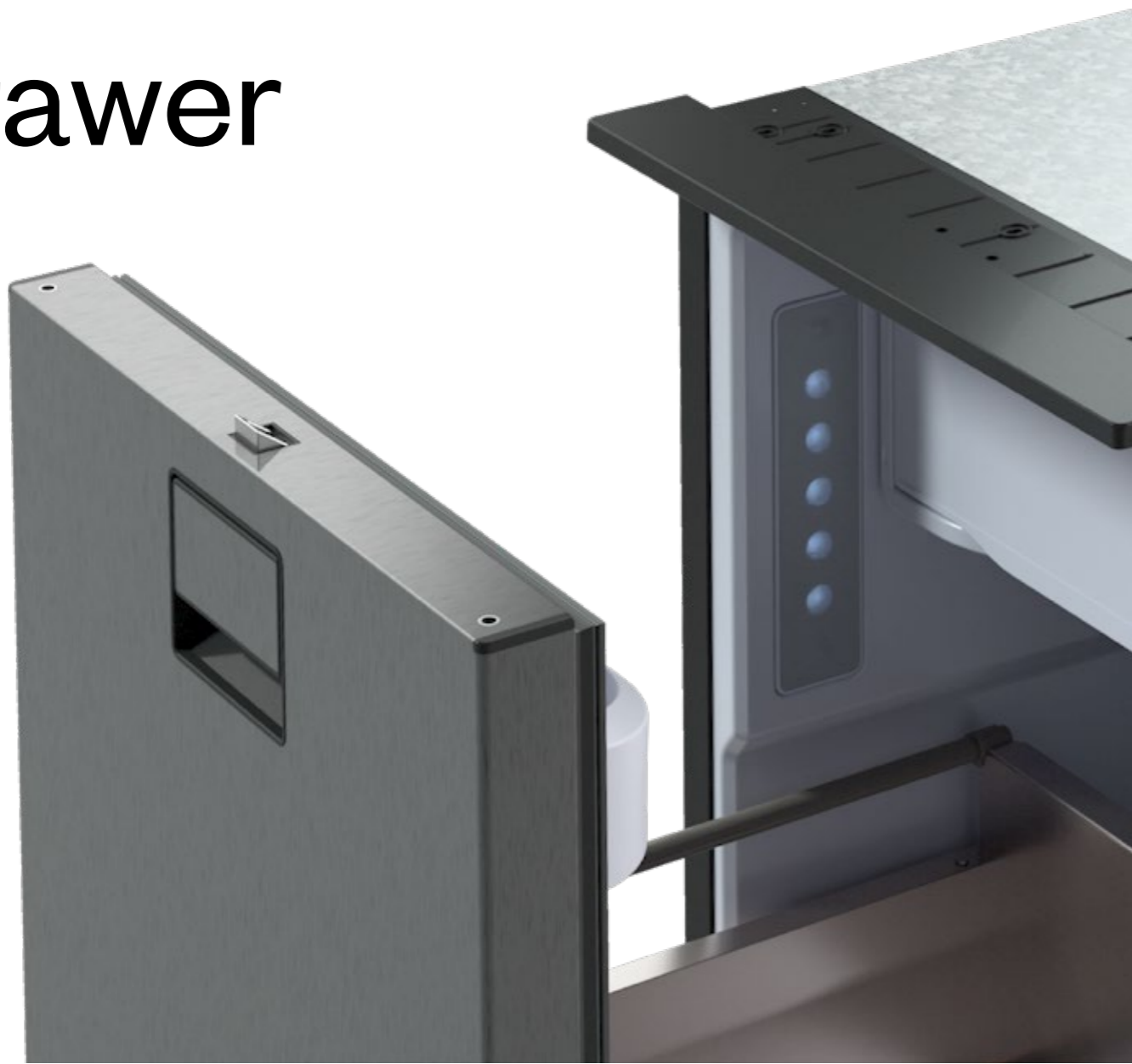

EN

The Drawer range is an ultra-compact design solution, perfect for flexible applications inside camper vans and smaller vans, and unconventional built-in installations that adapt to any space on board. The smooth glide opening mechanism allows you to easily open and close the refrigerator with a single movement because we use durable quality stainless steel guides with roller bearings. The internal space can be configured with extreme flexibility thanks to the drawers with repositionable compartments, the freezer drawer and accessories.

IT

La linea Drawer è la soluzione dal design compatto, perfetta per applicazioni flessibili all'interno di camper van e furgoni di dimensioni minori, e installazioni a incasso non convenzionali che si adattano a qualsiasi spazio a bordo. Il meccanismo di apertura a cassetto permette di aprire e chiudere facilmente il frigorifero con un unico movimento, reso fluido dalle indistruttibili guide in acciaio inox con cuscinetti a rullo. Lo spazio interno è configurabile con estrema flessibilità grazie ai cassetti con scomparti riposizionabili, al cassetto freezer e agli accessori ferma-prodotti.

DE

Die Baureihe Drawer ist die kompakte Designlösung für den flexiblen Einsatz in Vans und kleinen Wohnmobilen sowie für unkonventionelle Einbaulösungen an Bord. Durch den speziellen Mechanismus mit sehr widerständigen Edelstahlführungen und Rollenlagern der Schublade kann der Kühlschrank in einem einfachen Griff reibungslos geöffnet und geschlossen werden. Der Innenraum kann dank der Schubladen mit verschiebbaren Fächern, der Gefrierschublade und dem Zubehör zum Sichern der Lebensmittel äußerst flexibel gestaltet werden.

DRAWER 49 / 65 / 85

EN

The DR 49/65/85 models are compact front opening drawer units. The interior is thoughtfully designed to accommodate a wide variety of food container shapes and sizes. Key features include: sturdy drawers, with baskets, bottle holders, integrated adjustable bars of standard size, a compact freezer compartment (-6 °C) and internal blue LED light.

IT

I modelli DR 49/65/85 sono unità a cassetto di ingombro contenuto ad apertura frontale. Gli interni, progettati per ospitare lattine e cibo in formato internazionale, presentano robusti cassetti, con cestini, portabottiglie, barre regolabili integrate di dimensioni standard, vano freezer (-6°C) e luce interna blu a LED.

DE

Bei den Modellen DR 49/65/85 handelt es sich um kompakte Schubladenausführungen mit vorderer Öffnung. Der Innenraum, der für die Aufnahme von Dosen und Lebensmitteln in international gängigen Verpackungsformaten ausgelegt ist, verfügt über stabile Schubladen, mit Körben, Flaschenhaltern, integrierten verstellbaren Stangen in Standardgröße, Gefrierfach (-6°C) und interner blauer LED-Beleuchtung.

NEW
PRODUCT
2024



DR49

- 49 L
- 520x380x500 mm
- 16 Kg + 2,2 Kg pack
- DC 12/24V
- Power 40 W

DR65

- 65 L
- 525x450x526 mm
- 18,1 Kg + 2,7 Kg pack
- DC 12/24V
- Power 40 W

DR85

- 85 L
- 630x475x551 mm
- 22,5 Kg + 2,5 Kg pack
- DC 12/24V
- Power 36 W



DRAWER 130

EN

The largest compressor refrigerator of the Drawer line is the ultimate expression of Indel B technology for those who enjoy comfort on the road and want to add a touch of style to the interior of their camper van. Large inside and compact outside, Drawer 130 is designed to offer maximum flexibility and accessibility thanks to the convenient drawer front opening.

IT

Il frigorifero a compressore più capiente della linea Drawer è la massima espressione della tecnologia Indel B per chi non vuole rinunciare al comfort in viaggio e aggiungere un tocco di stile all'interno del proprio camper. Grande dentro e compatto fuori, Drawer 130 è progettato per offrire massima flessibilità ed accessibilità grazie alla comoda apertura frontale a cassetto.

DE

Der größte Kompressor-Kühlschrank der Serie Drawer ist der ultimative Ausdruck der Technologie von Indel B. Er ist für all diejenigen gedacht, die auch unterwegs nicht auf Komfort verzichten wollen und dem Innenraum ihres Wohnmobils einen Hauch von Stil verleihen möchten. Der Drawer 130 ist innen geräumig und außen kompakt. Die bequeme Schubladenöffnung sorgt für maximale Einsatzflexibilität und einfache Bedienbarkeit.

NEW
PRODUCT
2024



DR130

- 130 L
- 755x525x556 mm
- 26,5 Kg + 2,5 Kg pack
- DC 12/24V

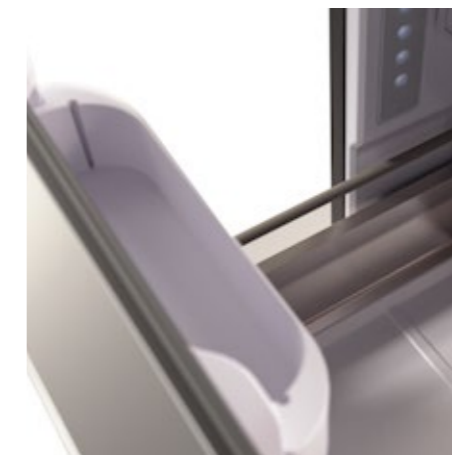

Customization



EN

Customizing the Drawer refrigerator range to match your interior cabinets style and color is easy. In the custom version the Drawer refrigerator panel is supplied with a fixing kit to make fitting your custom door panel to the door itself easy and durable.

IT

I frigoriferi a cassetto, versione custom, della linea Drawer sono progettati per consentire la personalizzazione dello sportello frontale e garantire una perfetta integrazione con lo stile degli interni. Il pannello del frigorifero a cassetto Drawer viene fornito con dei supporti di fissaggio per agevolare l'applicazione del pannello porta e garantire un accoppiamento stabile e sicuro nel tempo.

DE

Bei den Schubladenkühlschränken der Baureihe Drawer ist es bei der Version Custom möglich, die Fronttür individuell zu gestalten, um eine perfekte Integration in den Stil der Einrichtung zu garantieren. Die Kühlschrankschublade wird mit praktischen Befestigungswinkeln geliefert, an denen die Frontblende sehr einfach und auf Dauer stabil angebracht werden kann.





Name	Gross Volume	Freezer Volume	External dim. (HxWxD) mm	Weight	Installed power	Climate Class	Consumption 12-24V	Voltage	Certifications	Compressor	Internal light
DR49	49 L	10 L	520x380x500	16 Kg 2,2 Kg pack	40 W	ST	0,306 kWh/24h	DC 12/24V	CE EMC E-Mark	SECOP BD1.4F VSD	●
DR65	65 L	14,5 L	525x450x526	18,1 Kg 2,7 Kg pack	40 W	ST	0,330 kWh/24h	DC 12/24V	CE EMC E-Mark	SECOP BD1.4F VSD	●
DR85	85 L	11 L	630x475x551	22,5 Kg 2,5 Kg pack	36 W	ST	0,360 kWh/24h	DC 12/24V	CE EMC E-Mark	SECOP BDN45F	●
DR130	130 L	13 L	755x525x556	26,5 Kg 2,5 Kg pack	Under test	Under test	Under test	DC 12/24V	CE EMC E-Mark	SECOP BDN45F	●

EN

All refrigerators are rated according to the maximum and minimum ambient temperatures they can function in. The climatic classes assigned to refrigerators and freezers serve to ensure their perfect functioning in the environment in which they are located.

ST: Sub Tropical
Operation at room temperature from +16 °C to +38 °C
T: Tropical
Operation at room temperature from +16 °C to +43 °C

IT

Tutti i frigoriferi sono classificati in base alle temperature ambiente massime e minime in cui possono funzionare. Le classi climatiche assegnate ai frigoriferi e ai congelatori servono a garantirne il perfetto funzionamento nell'ambiente in cui si trovano.

ST: Subtropicale
Funzionamento a temperatura ambiente da +16 °C a +38 °C
T: Tropicale
Funzionamento a temperatura ambiente da +16 °C a +43 °C

DE

Alle Kühl- und Gefriergeräte werden nach der maximalen und minimalen Umgebungstemperatur, bei der sie betrieben werden können, klassifiziert. Die den Kühl- und Gefriergeräten zugeordneten Klimaklassen sollen den störungsfreien Betrieb in dem jeweiligen Aufstellungsraum sicherstellen.

ST: Subtropisch
Betrieb bei einer Umgebungstemperatur von +16 °C bis +38 °C
T: Tropisch
Betrieb bei einer Umgebungstemperatur von +16 °C bis +43 °C

Top Loaded

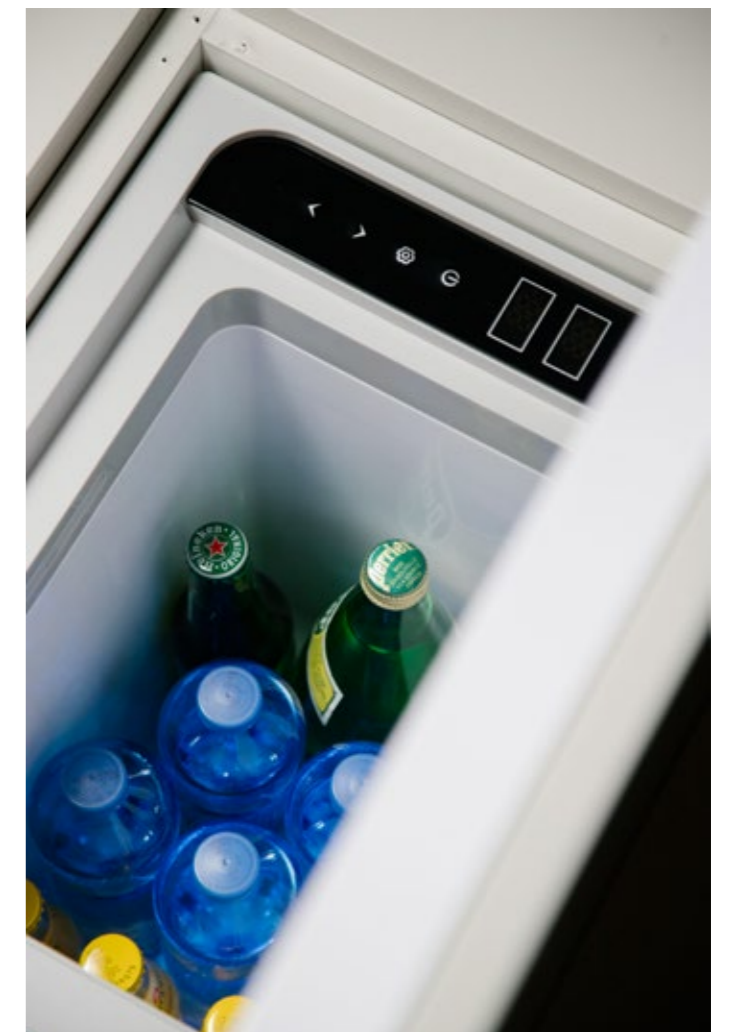

EN

The ideal compressor refrigerator for small spaces: the Top Loaded line, with vertical load, solves space problems related to hinged door opening without sacrificing storage capacity, refrigeration performance and energy efficiency. This feature makes them perfect for being easily installed under seats, storage chests or dinettes. A product that is compact in size but great in performance to optimize space, especially inside small vans and camper vans, without sacrificing the advantages of a real compressor refrigerator/freezer.

IT

Il frigorifero a compressore ideale per gli spazi ristretti: la linea Top Loaded a carico verticale limita i problemi di spazio legati all'apertura porta a battente senza rinunciare alla capacità di stoccaggio, alle prestazioni di refrigerazione e all'efficienza energetica. Questa caratteristica li rende perfetti per essere integrati facilmente sotto le sedute, nelle cassapanche o nelle dinette. Un prodotto compatto nelle dimensioni ma grande nelle prestazioni per ottimizzare al meglio lo spazio soprattutto all'interno di van di dimensioni ridotte e furgoni camperizzati, senza rinunciare ai vantaggi di un vero frigorifero/freezer a compressore.

DE

Der ideale Toplader Kompressor-Kühlschrank für enge Platzverhältnisse: Die senkrecht ausgerichtete Baureihe Top Loaded räumt durch Flügeltüren entstehende Platzprobleme ohne Abstriche bei Inhaltsvermögen, Kühlleistung und Energieeffizienz aus dem Weg. Diese Eigenschaft macht sie perfekt für die einfache Integration unter Sitzen, Sitzbänken oder Dinetten. Ein in Bezug auf die Größe kompaktes Produkt mit ausgezeichneter Leistung, das die Raumgestaltung insbesondere in Vans und kleinen Wohnmobilen optimiert, ohne auf die Vorteile eines echten Kompressor-Kühl-/Gefrierschranks zu verzichten.

TOP LOADED 41 / 29

EN

The TL 41/29 models are particularly suitable for installation inside storage chests thanks to their very compact dimensions, the flat bottom and the removable cooling unit with 1.5 m length of power cable for maximum positioning flexibility. The refrigeration performance with operating temperatures from +10 °C to -12 °C make them two extremely versatile, solid and reliable products.

IT

I modelli TL 41/29 sono particolarmente indicati per installazione all'interno delle cassapanche grazie alle dimensioni molto compatte, al fondo piatto e al gruppo refrigerante rimovibile con cavo di alimentazione da 1,5 m per la massima flessibilità di posizionamento. Le prestazioni di refrigerazione con temperatura di esercizio da +10°C a -12°C li rendono due prodotti estremamente versatili, solidi e affidabili.

DE

Die Modelle TL 41/29 sind aufgrund ihrer sehr kompakten Größe, des flachen Bodens und der abnehmbaren Kühleinheit mit 1,5m-Netzkabel für maximale Flexibilität bei der Positionierung besonders für den Einbau in Sitzbänken geeignet. Die Kühlleistung mit einer Betriebstemperatur von +10°C bis -12°C machen sie zu zwei äußerst vielseitigen, soliden und zuverlässigen Produkten.



TL41

- 41 L
- (469+161)*x342x500 mm
- 14 Kg + 1,5 Kg pack
- DC 12/24V
- Power 45 W

TL29

- 29 L
- 340x342x(500+155)* mm
- 11 Kg + 1,5 Kg pack
- DC 12/24V
- Power 45 W



(*) Remote compressor

TOP LOADED 27 / 16 / 30



EN

Top-loading refrigerators have been meticulously designed to be creatively installed/stored inside cabinets, storage chests or furnishing spaces. The top lid, which can be customized in the finish, has a recess in the internal part in the TL16 version that allows it to also contain 1.5 liter bottles despite the super-compact dimensions. Operating temperature from 0 °C to +10 °C with digital control of performance.

IT

Frigoriferi a carica dall'alto dal design rigoroso e razionale, progettato per un'installazione a incasso nel mobile della dinette e pensato per essere integrato al meglio nell'arredamento. Il coperchio superiore, personalizzabile nella finitura, ha nella versione TL16 un incavo nella parte interna che permette di contenere anche bottiglie da 1,5 lt nonostante le dimensioni supercompatte. Temperatura di esercizio da 0 °C a +10 °C con controllo digitale delle prestazioni.

DE

Toplader-Kühlschränke mit strengem und rationellem Design für den Einbau in die Dinette sind so konzipiert, dass sie sich optimal in das Dekor integrieren. Der in seiner Ausführung individuell gestaltbare Deckel hat bei der Version TL16 auf der Innenseite eine Aussparung, die es erlaubt, trotz der superkompakten Abmessungen auch 1,5-Liter-Flaschen aufzunehmen. Betriebstemperatur von 0 °C bis +10 °C mit digitaler Leistungsregelung.



TL27

- 27 L
- 411,5x605x268 mm
- 12,2 Kg + 2 Kg pack
- DC 12/24V
- Power 55 W

TL16

- 16 L
- 557x380x240 mm
- 12 Kg + 1,5 Kg pack
- DC 12/24V
- Power 40 W

TL30

- 30 L
- 723x440x250 mm
- 14 Kg + 2 Kg pack
- DC 12/24V
- Power 45 W



Top Loaded Technical Data



	Name	Gross Volume	External dim. (HxWxD) mm	Weight	Installed power	Climate Class	Consumption 12-24V	Voltage	Certifications	Compressor	Internal light
	TL41	41 L	(469+161)*x342x500 (* Remote compressor)	14 Kg 1,5 Kg pack	45 W	ST	0,270 kWh/24h	DC 12/24V	CE EMC E-Mark	SECOP BD1.4 AM	
	TL29	29 L	340x342x(500+155)* (* Remote compressor)	11 Kg 1,5 Kg pack	45 W	ST	0,250 kWh/24h	DC 12/24V	CE EMC E-Mark	SECOP BD1.4 AM	
	TL27	27 L	411,5x605x268	12,2 Kg 2 Kg pack	55 W	ST	0,325 kWh/24h	DC 12/24V	CE EMC E-Mark	SECOP BD1.4 AM	
	TL16	16 L	557x380x240	12 Kg 1,5 Kg pack	40 W	ST	0,155 kWh/24h	DC 12/24V	CE EMC E-Mark	SECOP BD1.4 AM	
	TL30	30 L	723x440x250	14 Kg 2 Kg pack	45 W	ST	0,265 kWh/24h	DC 12/24V	CE EMC E-Mark	SECOP BD1.4 AM	

EN

All refrigerators are rated according to the maximum and minimum ambient temperatures they can function in. The climatic classes assigned to refrigerators and freezers serve to ensure their perfect functioning in the environment in which they are located.

ST: Sub Tropical
Operation at room temperature from +16 °C to +38 °C
T: Tropical
Operation at room temperature from +16 °C to +43 °C

IT

Tutti i frigoriferi sono classificati in base alle temperature ambiente massime e minime in cui possono funzionare. Le classi climatiche assegnate ai frigoriferi e ai congelatori servono a garantirne il perfetto funzionamento nell'ambiente in cui si trovano.

ST: Subtropicale
Funzionamento a temperatura ambiente da +16 °C a +38 °C
T: Tropicale
Funzionamento a temperatura ambiente da +16 °C a +43 °C

DE

Alle Kühl- und Gefriergeräte werden nach der maximalen und minimalen Umgebungstemperatur, bei der sie betrieben werden können, klassifiziert. Die den Kühl- und Gefriergeräten zugeordneten Klimaklassen sollen den störungsfreien Betrieb in dem jeweiligen Aufstellungsraum sicherstellen.

ST: Subtropisch
Betrieb bei einer Umgebungstemperatur von +16 °C bis +38 °C
T: Tropisch
Betrieb bei einer Umgebungstemperatur von +16 °C bis +43 °C

Special



EN

The Special line refrigerators allow maximum use of all cabin space. They easily adapt and can be installed in the smallest trucks, motorhome, and vans also thanks to the portable compressor group (TB16 and TB30 AM Drawer).

A good and easy solution for those who want to use all the space and volume provided, placing the refrigerator in the empty drawers or in the storage compartment.

IT

I frigoriferi della linea Special sono stati pensati per sfruttare al massimo lo spazio dell'abitacolo. Si adattano facilmente ad installazioni negli spazi più angusti di furgoni, camper e van anche grazie al gruppo compressore amovibile (TB16 e TB30 AM Drawer). Una valida e conveniente alternativa a chi voglia utilizzare lo spazio e il volume previsto dal costruttore per posizionare il proprio frigorifero, inserendolo nei cassetti vuoti o nei vani porta oggetti.

DE

Die Kühlschränke der Linie Special sind so konzipiert, dass sie den Innenraum optimal nutzen. Dank der abnehmbaren Kompressoreinheit lassen sie sich problemlos auf engstem Raum in Lieferwagen, Wohnmobilen und Kleinbussen installieren (TB16 und TB30 AM Drawer). Eine gute und bequeme Alternative für diejenigen, die den vom Hersteller zur Verfügung gestellten Raum und Platz für den Kühlschrank nutzen wollen, indem Sie ihren Kühlschrank in leere Schubladen oder Staufächer stellen.

TB13

EN

Small on the outside but very spacious on the inside thanks to the new SECOP BD1.4 MICRO compressor. Made with top-quality materials, TB13 is ideal for the smallest spaces, i.e. it can be installed between the two front seats. This is possible thanks to the holding plate. The new compressor makes this "mini" refrigerator incredibly performing, with very low power consumption.

IT

Piccolo fuori ma grande dentro grazie al nuovissimo compressore SECOP BD1.4 MICRO. Realizzato con materiali di prima qualità, il TB13 è stato concepito per essere installato, grazie alla sua placca di fissaggio, anche negli spazi più piccoli, ad esempio tra i due sedili anteriori. Il nuovo compressore attribuisce a questo "mini" frigorifero eccellenti performance e consumi bassissimi.

DE

Außen klein, aber innen groß dank des brandneuen Kompressors SECOP BD1.4 MICRO. Der aus hochwertigen Materialien gefertigte TB13 wurde so konzipiert, dass er dank seiner Befestigungsplatte auch in den kleinsten Zwischenräumen, zum Beispiel zwischen den beiden Vordersitzen, installiert werden kann. Der neue Kompressor verleiht diesem "Mini"-Kühlschrank eine ausgezeichnete Leistung und einen sehr niedrigen Verbrauch.



TB13

- 13 L
- 360x225x535 mm
- 11 Kg + 1,2 Kg pack
- DC 12/24V
- Power 36 W

Slide TB 13

Slide Kit



TB16 / TB30 AM DRAWER



EN

TB16 and TB30 AM Drawer allow maximum use of the inside space. Thanks to the portable compressor, the refrigerator can be installed in the tightest spaces, moving it from the back to one of the two sides or the upper part, therefore modulating the three dimensions depending on the space available. The Easy Fix system allows an easy fixing from the inside (a screw from the inside out) or with two optional frontal flanges. If there is no storage unit, the refrigerator can be fixed to the floor with the 4 L brackets provided.

IT

TB16 e TB30 AM Drawer sono stati progettati per poter sfruttare al meglio gli spazi interni. Grazie al gruppo compressore amovibile è possibile installare il frigo anche negli spazi più angusti, spostandolo dal retro su uno dei due lati oppure nella parte superiore modulando così le 3 dimensioni a seconda dello spazio a disposizione. Il fissaggio può avvenire dall'interno con il pratico sistema Easy Fix (vite passante da interno verso esterno) oppure con due flange frontali opzionali. Inoltre viene fornito di 4 staffe a L per il fissaggio a pavimento in mancanza di un mobile contenitivo.

DE

TB16 und TB30 AM Drawer wurden so konzipiert, dass die Innenräume optimal genutzt werden können. Dank der abnehmbaren Kompressoreinheit ist es möglich, den Kühlschrank auch auf engstem Raum zu installieren, indem man ihn von hinten auf eine der beiden Seiten oder die Oberseite verschiebt und somit die 3 Dimensionen je nach verfügbarem Platz moduliert. Die Befestigung kann von innen mit dem praktischen Easy Fix-System (von innen nach außen durchschrauben) oder mit zwei optionalen Frontflanschen erfolgen. Darüber hinaus wird er mit 4 L-förmigen Halterungen zur Befestigung am Boden geliefert, falls kein Einbauschrank vorhanden ist.





TB16AM Drawer

- 16 L
- 240x380x530 mm
- 10 Kg + 2 Kg pack
- DC 12-24V
- Power 45 W

TB30AM Drawer

- 30 L
- 250x440x700 mm
- 18 Kg + 3 Kg pack
- DC 12-24V
- Power 45 W



Name	Gross Volume	External dim. (HxWxD) mm	Weight	Installed power	Climate Class	Consumption 12-24V	Voltage	Compressor	Thermostatic regulation	Fixing kit
 TB13	13 L	360x225x535	11 Kg 1,2 Kg pack	36 W	ST	0,240 kWh/24h	DC 12/24V	BD micro FSD	•	•
 TB16AM DRAWER	16 L	240x380x530	10 Kg 2 Kg pack	45 W	ST	0,180 kWh/24h	DC 12/24V	SECOP BD1.4F	•	
 TB30AM DRAWER	30 L	250x440x700	18 Kg 3 Kg pack	45 W	ST	0,270 kWh/24h	DC 12/24V	SECOP BD35F	•	•

EN

All refrigerators are rated according to the maximum and minimum ambient temperatures they can function in. The climatic classes assigned to refrigerators and freezers serve to ensure their perfect functioning in the environment in which they are located.

ST: Sub Tropical
Operation at room temperature from +16 °C to +38 °C
T: Tropical
Operation at room temperature from +16 °C to +43 °C

IT

Tutti i frigoriferi sono classificati in base alle temperature ambiente massime e minime in cui possono funzionare. Le classi climatiche assegnate ai frigoriferi e ai congelatori servono a garantirne il perfetto funzionamento nell'ambiente in cui si trovano.

ST: Subtropicale
Funzionamento a temperatura ambiente da +16 °C a +38 °C
T: Tropicale
Funzionamento a temperatura ambiente da +16 °C a +43 °C

DE

Alle Kühl- und Gefriergeräte werden nach der maximalen und minimalen Umgebungstemperatur, bei der sie betrieben werden können, klassifiziert. Die den Kühl- und Gefriergeräten zugeordneten Klimaklassen sollen den störungsfreien Betrieb in dem jeweiligen Aufstellungsraum sicherstellen.

ST: Subtropisch
Betrieb bei einer Umgebungstemperatur von +16 °C bis +38 °C
T: Tropisch
Betrieb bei einer Umgebungstemperatur von +16 °C bis +43 °C

Optional



AC/DC Adapter Power pack

This product is a power supply unit designed to power equipment, such as refrigerators or freezers, that operate on direct current (DC). The power pack manages the power supply to products intelligently, using AC power when it is available and thus saving battery power.

è un alimentatore esterno concepito per fornire energia ad apparecchiature quali frigoriferi o freezer che funzionano in corrente continua (DC). L'alimentatore gestisce l'alimentazione al prodotto in maniera intelligente, sfruttando l'energia proveniente dalla corrente alternata quando questa è disponibile, e permettendo così di risparmiare l'energia della batteria.

Das Produkt ist ein Netzteil für die Stromversorgung von Geräten wie Kühlschränken oder Gefriertruhen, die mit Gleichstrom (DC) betrieben werden. Das Netzteil verwaltet die Stromversorgung des Geräts auf intelligente Weise, indem es den Strom aus der Steckdose nutzt, wenn er verfügbar ist, und so Batteriestrom spart.





PORTABLE REFRIGERATORS

FRIGORIFERI
PORTATILI

TRAGBARE
KÜHLSCHRÄNKE

Steel	98
Travel Box	106
LiON Cooler	114

Practicality and performance everywhere.

Whether you are going out for just a few hours, taking a vacation on the road, or having a party in your backyard, Indel B's OFF portable refrigerators and freezers are the best solutions to store your food and drinks at the right temperature in all situations.

Created in different models and with a complete set of accessories to adapt to all needs, they offer high performance and versatility, and ensure great autonomy and temperatures up to -18°C in 12V mode. The perfect travel companion for those who love living outdoors.

IT

Praticità e performance in qualsiasi ambiente.

Che sia per un'uscita di poche ore, una vacanza on-the-road o per una festa in giardino, i frigoriferi e freezer portatili OFF by Indel B sono la migliore soluzione per avere cibi e bevande alla giusta temperatura e in ogni condizione di utilizzo.

Ideati in diversi modelli e completi di accessori per adattarsi ad ogni situazione, offrono alte prestazioni e versatilità garantendo grande autonomia e temperature fino a -18°C in modalità 12V. I compagni di viaggio ideali per chi ama vivere all'aria aperta.

DE

Praxistauglichkeit und Leistung in jeder Umgebung.

Ob für einen Ausflug von ein paar Stunden, einen Urlaub "on the road" oder eine Gartenparty, die tragbaren Kühl- und Gefrierschränke OFF von Indel B sind die beste Lösung, um Speisen und Getränke bei der richtigen Temperatur und unter allen Einsatzbedingungen zu haben.

Sie sind in verschiedenen Modellen und komplett mit Zubehör zur Anpassung an jede Situation konzipiert und bieten hohe Leistung und Vielseitigkeit, die eine große Autonomie und Temperaturen bis -18°C im 12V-Modus garantieren. Die idealen Reisebegleiter für alle, die das Outdoor-Leben lieben.

Products



Steel



Travel Box



LiON Cooler

Steel



EN

The Steel range of portable refrigerators is tough-built, designed to withstand extreme weather and the rugged conditions you face when off-road or overlander driving. The new black matte finish completely transforms the aesthetics of the entire line. The evolution of the Steel range includes retractable handles with a new design for improved portability, corner bumpers, even more resistant snap closures with a hole for the integrated security padlock and new reinforced hinges with four anchor points. Also completely new is the power and temperature control panel with integrated bluetooth connectivity for performance monitoring via smartphone.

IT

La gamma di frigoriferi portatili Steel è progettata per resistere a condizioni climatiche estreme e alle sollecitazioni derivanti da una guida prolungata in off-road. Il nuovo rivestimento esterno con finitura nera opaca trasforma interamente l'estetica di tutta la linea. L'evoluzione della gamma Steel include maniglie retrattili dal nuovo design per una migliore portabilità, paracolpi angolari, chiusure a scatto ancora più resistenti e con foro per il lucchetto di sicurezza integrato e nuove cerniere rinforzate con quattro punti di ancoraggio. Completamente nuovo anche il pannello di alimentazione e controllo della temperatura con connettività bluetooth integrata per il monitoraggio delle prestazioni via smartphone.

DE

Die tragbaren Kühlschränke der Baureihe Steel sind so konzipiert, dass sie extremen Witterungsbedingungen und der Beanspruchung durch lange Geländefahrten standhalten. Das neue Außengehäuse mit mattschwarzem Finish verändert die Ästhetik der gesamten Linie komplett. Die Weiterentwicklung der Baureihe Steel umfasst neu gestaltete, versenkbare Griffe für verbesserte Tragbarkeit, Winkelschutzvorrichtungen, noch stärkere Druckknöpfe mit integriertem Vorhängeschlossloch und neue verstärkte Scharniere mit vier Verankerungspunkten. Völlig neu ist auch das Leistungs- und Temperatur-Bedienfeld mit integrierter Bluetooth-Konnektivität zur Leistungsüberwachung per Smartphone.

TB 46 / 60 STEEL BLACK

EN

The refrigerators belonging to the STEEL range stand out for their large capacity and high performances under all conditions. They have been designed for being used in extremely warm climate areas and for reaching and keeping the set temperature though consuming very little energy.

IT

I frigoriferi della linea STEEL si caratterizzano per la grande capacità di carico ed elevate performance sotto ogni condizione di utilizzo. Progettati per situazioni climatiche difficili e zone impervie, i modelli STEEL garantiscono sempre le temperature impostate consentendo bassissimi consumi.

DE

Die Kühlboxen der Serie STEEL zeichnen sich aus durch die große Ladekapazität und hohe Leistung unter allen Einsatzbedingungen. Entwickelt für schwierige klimatische Bedingungen und unzugängliche Gebiete, garantieren die STEEL Modelle immer die Einhaltung der eingestellten Temperaturen bei sehrniedrigen Verbräuche.



TB46 STEEL BLACK

TB60 STEEL BLACK

- 45 L
- 488x682x405 mm
- 22 Kg + 2 Kg pack
- DC 12/24V
- Power 85 W

- 60 L
- 585x682x405 mm
- 24 Kg + 2,5 Kg pack
- DC 12-24V
- Power 85 W



TB 74 / 100 / 130 STEEL BLACK

EN

The TB74, TB100 and TB130 STEEL models are characterised by their large and flexible load capacity. The thick insulation (50 mm) common to all models in the STEEL line, allows low electricity consumption.

IT

I modelli TB74, TB100 e TB130 STEEL si caratterizzano per la grande e flessibile capacità di carico. L'elevato isolamento (50 mm) comune a tutti i modelli della linea STEEL permette consumi elettrici molto contenuti.

DE

Die Modelle TB74, TB100 und TB130 STEEL zeichnen sich durch ihre große und flexible Befüllungskapazität aus. Die hohe Isolierung (50 mm), die alle Modelle der Serie STEEL auszeichnet, ermöglicht geringen Stromkonsum.



TB74 STEEL BLACK

TB100 STEEL BLACK

TB130 STEEL BLACK

- 71 L
- 499x810x492 mm
- 28 Kg + 3,5 Kg pack
- DC 12/24V
- Power 85 W

- 97 L
- 616x810x492 mm
- 31 Kg + 4,5 Kg pack
- DC 12/24V
- Power 85 W

- 124 L
- 744x810x492 mm
- 34 Kg + 5,5 Kg pack
- DC 12/24V
- Power 85 W

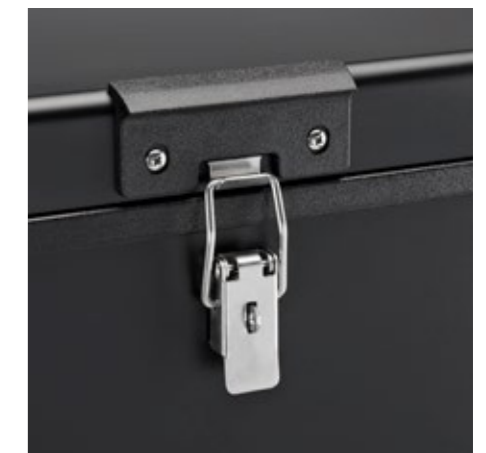

TB 65 / 92 / 118 DOUBLE DOOR STEEL BLACK

EN

The double door - double thermostat version allows to set two different temperatures in the two different cabinets. The handles are sturdy (granting safety during transport and an easy fix) and spring loaded (reducing the in-vehicle encumbrance). In order to grant an easy use in small spaces the lids are removable.

IT

La versione doppia porta - doppio termostato permette due diverse temperature in due vani. Le maniglie sono robuste (per permettere sicurezza nel trasporto e nel fissaggio) e retrattili (per ridurre l'ingombro a bordo del veicolo). I coperchi sono rimovibili per una fruizione più comoda in volumi ristretti.

DE

Die Doppeltür - Doppelthermostat Ausführung ermöglicht zwei verschiedene Temperaturen in zwei Kammern. Die Griffe sind robust (für Sicherheit beim Transport und zum Befestigen), und sie sind versenkbar (um des Durcheinander im Fahrzeug zu reduzieren). Die Deckel sind für eine bessere Nutzung bei beschränktem Platz abnehmbar.



TB65 DD STEEL BLACK

- 60 L (36 L / 24 L)
- 499x810x492 mm
- 29,5 Kg + 3,5 Kg pack
- DC 12/24V
- Power 85 W

TB92 DD STEEL BLACK

- 83 L (47 L / 36 L)
- 616x810x492 mm
- 32,5 Kg + 4,5 Kg pack
- DC 12/24V
- Power 85 W

TB118 DD STEEL BLACK

- 107 L (60 L / 47 L)
- 744x810x492 mm
- 35,5 Kg + 5,5 Kg pack
- DC 12/24V
- Power 85 W



Optional



250 Wh Magnetic Power Bank

Power bank to charge the refrigerator when in movement or a power supply is not available. This Power Bank is equipped with magnetic support that sticks to the refrigerator's surface. It also has 3 outputs: DC 13.3V, USB-C and USB ports. Equipped with a standard transformer and power cable.

Alimentatore portatile per ricaricare il frigo anche in movimento o lontano da fonti di alimentazione. La Power Bank è dotata di supporto magnetico per aderire alle superfici del frigo e dispone di 3 diverse tipologie di uscita: DC 13.3V, porta USB-C e USB. Viene fornita con trasformatore e cavo di alimentazione.

Tragbares Netzteil zum Aufladen des Kühlschranks unterwegs oder fernab von anderen Stromquellen. Die Powerbank ist mit einer magnetischen Halterung ausgestattet, um an Kühlschrankoberflächen zu haften, und verfügt über 3 verschiedene Ausgangstypen: DC 13,3V, USB-C-Anschluss und USB. Wird mit Transformator und Netzkabel geliefert.



Sliding base

The slide base is made of solid powder-coated steel with an anti-scratch finish. The locking / unlocking mechanism allows the sled to be anchored in 3 positions until complete extraction. The sliding base, already pre-drilled for fixing points, also includes 4 straps to secure your fridge to the sled and ensure safety during the journey.

Realizzata in solido acciaio verniciato a polvere con finitura antigraffio e meccanismo di scorrimento della slitta in 3 posizioni. Già preforata per i punti di fissaggio, include 4 cinghie di sicurezza.







Die Schlittenbasis besteht aus massivem, pulverbeschichtetem Stahl mit kratzfester Beschichtung. Der Ver-/Entriegelungsmechanismus ermöglicht die Verankerung des Schlittens in 3 Positionen bis zum vollständigen Herausziehen. Der Schlitten, der bereits für Befestigungspunkte vorgebohrt ist, enthält auch 4 Gurte, um Ihren Kühlschrank am Schlitten zu befestigen und die Sicherheit während der Fahrt zu gewährleisten.

Adapter

AC to DC converter for indoor or outdoor use. Compatible with all DC OFF refrigerators.

Trasformatore da AC a DC per uso interno o esterno. Compatibile con tutti i frigoriferi DC OFF.

AC/DC-Wandler für den Innen- und Außenbereich. Kompatibel mit allen DC OFF Kühlschränken.

Name	Gross Volume	Lid	External dim. (HxWxD) mm	Weight	Installed power	Consumption 12-24V	Voltage	Certifications	Compressor	Thermostatic regulation	Internal light	Bluetooth
 TB46 STEEL BLACK	45 L	Single	488x682x405	22 Kg 2 Kg pack	85 W	0,231 kWh/24h	DC 12/24V	CE CB E-Mark EMC	SECOP BD35F	•	•	•
 TB60 STEEL BLACK	60 L	Single	585x682x405	24 Kg 2,5 Kg pack	85 W	0,231 kWh/24h	DC 12/24V	CE CB E-Mark EMC	SECOP BD35F	•	•	•
 TB74 STEEL BLACK	71 L	Single	499x810x492	28 Kg 3,5 Kg pack	85 W	0,231 kWh/24h	DC 12/24V	CE CB E-Mark EMC	SECOP BD50F	•	•	•
 TB100 STEEL BLACK	97 L	Single	616x810x492	31 Kg 4,5 Kg pack	85 W	0,262 kWh/24h	DC 12/24V	CE CB E-Mark EMC	SECOP BD50F	•	•	•
 TB130 STEEL BLACK	124 L	Single	744x810x492	34 Kg 5,5 Kg pack	85 W	0,282 kWh/24h	DC 12/24V	CE CB E-Mark EMC	SECOP BD50F	•	•	•
 TB65 DD STEEL BLACK	60 L (36 L / 24 L)	Double	499x810x492	29,5 Kg 3,5 Kg pack	85 W	0,230 kWh/24h	DC 12/24V	CE CB E-Mark EMC	SECOP BD50F	•	•	•
 TB92 DD STEEL BLACK	83 L (47 L / 36 L)	Double	616x810x492	32,5 Kg 4,5 Kg pack	85 W	0,267 kWh/24h	DC 12/24V	CE CB E-Mark EMC	SECOP BD50F	•	•	•
 TB118 DD STEEL BLACK	107 L (60 L / 47 L)	Double	744x810x492	35,5 Kg 5,5 Kg pack	85 W	0,286 kWh/24h	DC 12/24V	CE CB E-Mark EMC	SECOP BD50F	•	•	•

Travel Box



EN

The all range of Travel Box portable compressor refrigerators has been completely upgraded with new colors, materials and digital control panel; this international best-seller is your reliable, versatile and essential portable fridge companion. Travel Box can go wherever your outdoor life takes you; car camping, fishing and 4x4 overlanding. Travel Boxes are energy saving with built-in features to protect your vehicle battery. When space is a premium but you need to keep food and drinks chilled, Travel Box has a size to fit your needs.

IT

La gamma dei frigoriferi portatili a compressore Travel Box è stata completamente rinnovata nei colori e nei materiali, con un nuovo pannello di controllo digitale, mantenendo l'affidabilità e la versatilità di utilizzo che li hanno resi un best-seller internazionale. Possono essere utilizzati in diversi contesti: dal tempo libero ai veicoli industriali fino ai pullman per il trasporto di piccole derrate alimentari durante i viaggi. I Travel Box sono stati concepiti pensando a tutte le esigenze che possono insorgere durante gli spostamenti, alla sicurezza della guida, al risparmio energetico e alla vivibilità dello spazio in cui saranno trasportati. Per questi motivi i frigoriferi Travel Box sono inimitabili compagni di viaggio.

DE

Die Serie der tragbaren Kompressor-Kühlschränke von Travel Box wurde in Farben und Materialien komplett erneuert und mit einem neuen digitalen Bedienfeld ausgestattet, wobei die Zuverlässigkeit und Vielseitigkeit in der Anwendung beibehalten wurde, die sie zu einem internationalen Bestseller gemacht haben. Sie sind sehr vielseitig einsetzbar: von Freizeit- und Industriefahrzeugen bis hin zu Bussen für den Transport von kleinen Lebensmitteln auf Fahrten. Die Travel Boxen wurden unter Berücksichtigung aller Bedürfnisse, die während der Reise auftreten können, sowie der Fahrsicherheit, der Energieeinsparung und der Bewohnbarkeit des Raumes, in dem sie transportiert werden, entwickelt. Aus diesen Gründen sind die Travel Box Kühlschränke unentbehrliche Reisebegleiter.



TB 15 / 18 BLACK

EN

Small outside but big inside thanks to the brand new SECOP BD1.4 MICRO compressor which combines excellent performance with very low consumption. The TB15 and TB18 have been designed to be installed even in the smallest spaces and to be easily transported thanks to their low weight.

IT

Piccoli fuori ma grandi dentro grazie al nuovissimo compressore SECOP BD1.4 MICRO che unisce performance eccellenti a consumi bassissimi. Il TB15 e il TB18 sono stati concepiti per essere installati anche negli spazi più piccoli e per essere facilmente trasportati grazie al loro peso ridotto.

DE

Außen klein, innen groß - dank des brandneuen SECOP BD1.4 MICRO-Kompressors, der exzellente Leistung mit sehr geringem Verbrauch kombiniert. Die TB15 und TB18 sind so konzipiert, dass sie auf kleinstem Raum Platz finden und durch ihr geringes Gewicht leicht zu transportieren sind. Der TB45 eignet sich ideal als Standby-Kühlschrank sowohl unterwegs als auch zu Hause, dank seines großzügigen Formats und des Designs des sehr geräumigen Kühlfachs.



TB15 BLACK

- 15 L
- 375x235x566 mm
- 8,2 Kg + 1,2 Kg pack
- DC 12/24V
- Power 35 W

TB18 BLACK

- 18 L
- 420x235x566 mm
- 8,6 Kg + 1,2 Kg pack
- DC 12/24V
- Power 35 W



TB 31 / 41 / 51 BLACK

EN

Medium to large-size refrigerators for intensive use. The BD 1.4F MICRO FSD Secop compressor specifically designed for "automotive" products and their high performances make them suitable for many applications, for instance in cars, trucks, RVs and even in extreme off road vehicles.

IT

Frigoriferi di medie-grandi dimensioni per usi intensivi. Il compressore SECOP BD 1.4F MICRO FSD progettato per uso "automotive" nonché le elevate performance consentono le più svariate applicazioni: dall'auto al veicolo commerciale, dal camper al fuoristrada più estremo.

DE

Kühlboxen von mittleren Größe für den intensiven Gebrauch. Der für den automobilen Bereich entwickelte Kompressor Secop BD 1.4F MICRO FSD sowie die hohe Leistung, erlauben den Einsatz in unterschiedlichsten Anwendungen, vom PKW bis zum LKW, vom Camper bis zum extremsten Offroad.



TB31 BLACK

- 30 L
- 380x350x585 mm
- 11,6 Kg + 2,2 Kg pack
- DC 12/24V
- Power 55 W

TB41 BLACK

- 40 L
- 445x350x585 mm
- 12,6 Kg + 2,2 Kg pack
- DC 12/24V
- Power 55 W

TB51 BLACK

- 47 L
- 530x350x585 mm
- 14,2 Kg + 2,2 Kg pack
- DC 12/24V
- Power 55 W



Optional



Slide TB BLACK

The slide base is made of solid powder-coated steel with an anti-scratch finish. The locking / unlocking mechanism allows the sled to be anchored in 3 positions until complete extraction. The sliding base, already pre-drilled for fixing points, also includes 4 straps to secure your fridge to the sled and ensure safety during the journey.

Realizzata in solido acciaio verniciato a polvere con finitura antigraffio e meccanismo di scorrimento della slitta in 3 posizioni. Già preforata per i punti di fissaggio, la slitta include 4 cinghie di sicurezza.

Die Schlittenbasis besteht aus massivem, pulverbeschichtetem Stahl mit kratzfester Beschichtung. Der Ver-/Entriegelungsmechanismus ermöglicht die Verankerung des Schlittens in 3 Positionen bis zum vollständigen Herausziehen.

Der Schlitten, der bereits für Befestigungspunkte vorgebohrt ist, enthält auch 4 Gurte, um Ihren Kühlschrank am Schlitten zu befestigen und die Sicherheit während der Fahrt zu gewährleisten.



Metal base

Fixing plate to anchor the fridge to the vehicle floor.

Piastra di fissaggio per ancorare il frigo al pavimento del veicolo.

Befestigungsplatte zur Verankerung des Kühlschranks auf dem Fahrzeugboden.

Handles

Easy to install them and included with TB41 and TB51. They are optional with the TB31.

Di semplice installazione incluse nei TB41 e TB51, mentre opzionali per il TB31.

Einfach zu installieren und im Lieferumfang der TB41 und TB51 enthalten. Beim TB31 sind sie optional erhältlich.

Adapter

AC to DC converter for indoor or outdoor use. Compatible with all DC OFF refrigerators.

Trasformatore da AC a DC per uso interno o esterno. Compatibile con tutti i frigoriferi DC OFF.

AC/DC-Wandler für den Innen- und Außenbereich. Kompatibel mit allen DC OFF Kühlschränken.



Name	Gross Volume	External dim. (HxWxD) mm	Weight	Installed power	Consumption 12-24V	Consumption 230V	Voltage	Certifications	Compressor	Thermostatic regulation	Fixing kit	Internal light
 TB15 BLACK	15 L	375x235x566	8,2 Kg 1,2 Kg pack	35 W	0,300 kWh/24h	—	DC 12/24V	CE EMC E-Mark	SECOP BD1.4F FSD	●	Optional	●
 TB18 BLACK	18 L	420x235x566	8,6 Kg 1,2 Kg pack	35 W	0,365 kWh/24h	—	DC 12/24V	CE EMC E-Mark	SECOP BD1.4F FSD	●	Optional	●
 TB31 BLACK	30 L	380x350x585	11,6 Kg 2,2 Kg pack	55 W	0,230 kWh/24h	—	DC 12/24V	CE EMC E-Mark	SECOP BD35F	●	Optional	●
 TB41 BLACK	40 L	445x350x585	12,6 Kg 2,2 Kg pack	55 W	0,320 kWh/24h	—	DC 12/24V	CE EMC E-Mark	SECOP BD35F	●	Optional	●
 TB51 BLACK	47 L	530x350x585	14,2 Kg 2,2 Kg pack	55 W	0,380 kWh/24h	—	DC 12/24V	CE EMC E-Mark	SECOP BD35F	●	Optional	●

LiON Cooler



EN

All the refrigerating energy and power whenever and wherever you want: LiON Cooler is the family of portable refrigerators with extractable battery to fully enjoy the freedom of travelling without giving up on comfort. No matter how far the destination may be, LiON Cooler is the ideal companion for travelling in complete freedom, thanks to the battery power supply which ensures over 20 hours of life without having to plug it into an energy source. LiON Cooler is designed for intense outdoor activities; its flexibility and versatility are a pleasant discovery and make it hard to live without.

IT

Tutta l'energia e la potenza refrigerante dove e quando vuoi: LiON Cooler è la famiglia di frigoriferi portatili a batteria estraibile per vivere a pieno la libertà del viaggio senza rinunciare al comfort. Non importa quanto sia lontana la meta, LiON Cooler è il compagno ideale di viaggi in completa libertà, grazie all'alimentazione a batteria che permette un'autonomia di oltre 20 ore in assenza di collegamento ad una fonte di energia elettrica. LiON Cooler ha un design progettato per un uso outdoor intenso, la sua flessibilità e la versatilità di utilizzo è una piacevole scoperta alla quale è difficile rinunciare.

DE

Die ganze Energie und Kühlleistung, wo und wann immer Sie wollen: LiON Cooler ist die Familie der tragbaren, mit austauschbarer Batterie betriebenen, Kühlschränke, mit denen Sie die Freiheit des Reisens in vollen Zügen genießen können, ohne auf Komfort verzichten zu müssen. Unabhängig davon, wie weit das Ziel entfernt ist, ist der LiON Cooler der ideale Begleiter, um in völliger Freiheit zu reisen, dank seiner Akku-Stromversorgung, die eine Autonomie von mehr als 20 Stunden ohne Anschluss an eine Stromquelle ermöglicht. Der LiON Cooler hat ein Design, das für den intensiven Außeneinsatz konzipiert wurde. Seine Flexibilität und Vielseitigkeit ist eine angenehme Entdeckung, auf die man nur schwer verzichten möchte.

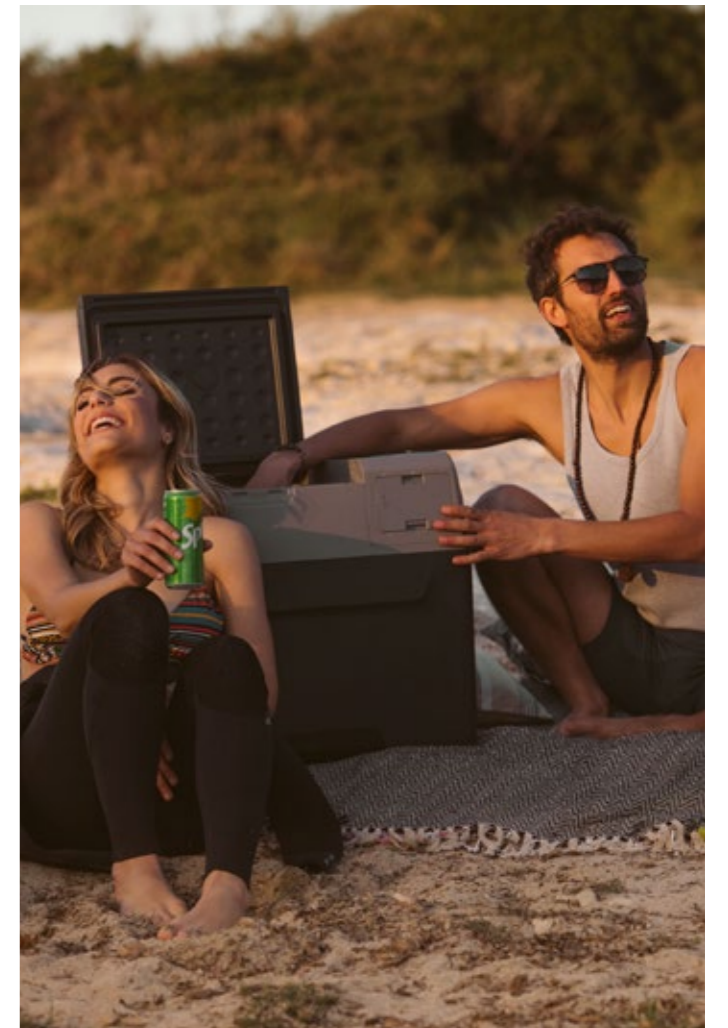
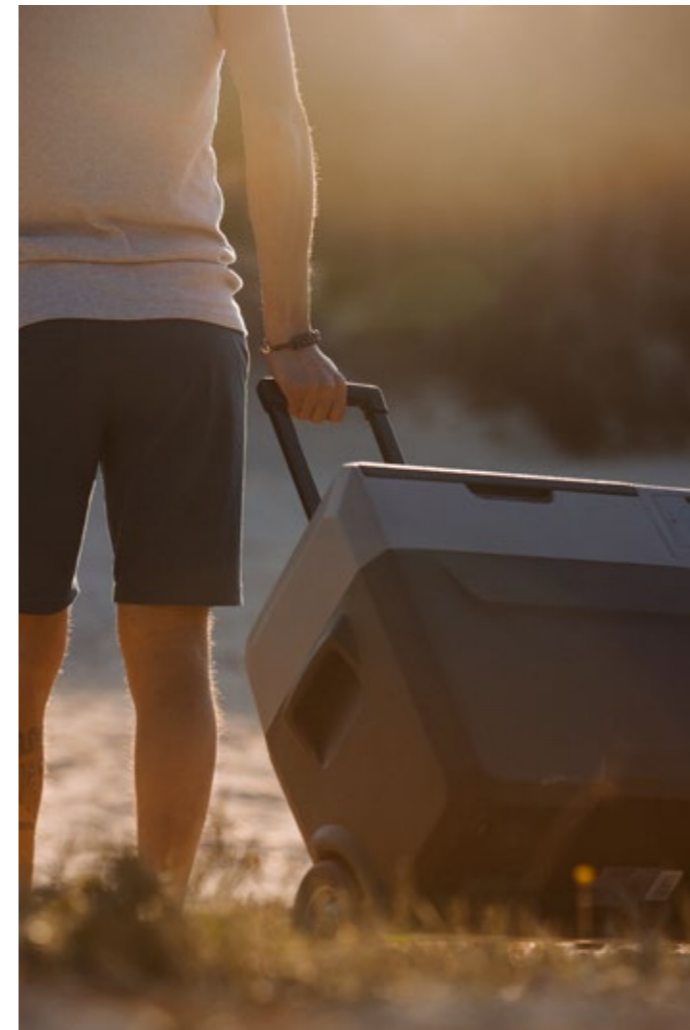

LiON Cooler X30A / X40A / X50A

EN

LiON Cooler is equipped with a compact and efficient compressor which ensures excellent refrigeration performance, even in extremely high temperatures. The light and robust structure integrates two rubber wheels and an extractable telescopic handle. LiON Cooler's control unit is simple and intuitive, with a digital, user-friendly interface and integrated Bluetooth connection to monitor functioning parameters. The extractable integrated battery ensures up to 21 hours of life and can be recharged through solar panel, 12V plug or connecting it to the traditional power source.

IT

Equipaggiato con compressore compatto ed efficiente che garantisce eccellenti prestazioni di refrigerazione anche a temperature esterne elevate. La struttura leggera e robusta integra una coppia di ruote in gomma e un'impugnatura estraibile telescopica. Il pannello di controllo del LiON Cooler è semplice e intuitivo, con un'interfaccia digitale user-friendly e connettività bluetooth integrata, per monitorare i parametri di funzionamento. La batteria integrata estraibile garantisce fino a 21 ore di autonomia e può essere ricaricata tramite pannello solare, presa 12V o collegandola alla rete elettrica.

DE

Er ist mit einem kompakten und effizienten Kompressor ausgestattet, der auch bei extremen Außentemperaturen eine ausgezeichnete Kälteleistung garantiert. Die leichte und robuste Struktur integriert zwei Gummiräder und einen ausziehbaren Teleskopgriff. Das Steuerelement des LiON Cooler ist einfach und intuitiv, mit einer benutzerfreundlichen digitalen Schnittstelle und integrierter Bluetooth-Konnektivität zur Überwachung der Betriebsparameter. Die integrierte austauschbare Batterie garantiert eine Autonomie von bis zu 21 Stunden und kann über ein Solarzelle, eine 12V-Steckdose oder durch Anschluss an das Stromnetz aufgeladen werden.



LiON Cooler X30A

- 30 L
- 399x635x405 mm
- 13,5 Kg
- DC 12-24V+AC 115-230V (optional)
- 45 W



LiON Cooler X40A

- 40 L
- 509x635x405 mm
- 14,9 Kg
- DC 12-24V+AC 115-230V (optional)
- 45 W



LiON Cooler X50A

- 50 L
- 580x635x405 mm
- 15,4 Kg
- DC 12-24V+AC 115-230V (optional)
- 45 W



Optional



Replaceable battery

A 173Wh lithium ion, rechargeable and replaceable, battery that powers up to 21 hours.

Fino a 21 ore di autonomia con alimentazione a batteria estraibile agli Ioni di Litio da 173Wh.

Eine wiederaufladbare und austauschbare 173Wh Lithium-Ionen-Batterie, die bis zu 21 Stunden Strom liefert.



Solar panel 90W

Three 30W solar panels folding in a suitcase to charge your battery.

Tre pannelli solari uniti in una suite case da 90W ideale per la ricarica della batteria in assenza di energia.

Drei 30W-Solarpaneele, die sich in einem Koffer zusammenfalten lassen, um Ihre Batterie aufzuladen.



Adapter

AC to DC converter for indoor or outdoor use. Compatible with all DC OFF refrigerators.

Trasformatore da AC a DC per uso interno o esterno. Compatibile con tutti i frigoriferi DC OFF.

AC/DC-Wandler für den Innen- und Außenbereich. Kompatibel mit allen DC OFF Kühlschränken.



Name	Gross Volume	External dim. (HxWxD) mm	Weight	Installed power	Battery	Consumption 12-24V	Voltage	Certifications	Compressor	Bluetooth
LiON Cooler X30A	30 L	399x635x405	13,5 Kg	45 W	173Wh (patent pending)	0,210 kWh/24h	DC 12/24V AC 115/230V 50-60Hz	CE EMC CB	Direct current	•
LiON Cooler X40A	40 L	509x635x405	14,9 Kg	45 W	173Wh (patent pending)	0,230 kWh/24h	DC 12/24V AC 115/230V 50-60Hz	CE EMC CB	Direct current	•
LiON Cooler X50A	50 L	580x635x405	15,4 Kg	45 W	173Wh (patent pending)	0,250 kWh/24h	DC 12/24V AC 115/230V 50-60Hz	CE EMC CB	Direct current	•



TRAVEL SAFETY

SICUREZZA
IN VIAGGIO

SICHERHEIT
AUF REISEN

Safe Box

SAFE BOX 10 / 30



EN

Indel B's Safe Boxes present a solid steel structure, motorized closing system with wire keyboard with a LED backlit display. After 3 mistakes, the safe locks for 15 minutes. If necessary, you can always open the safe with a mechanical key or a master code.

IT

Le Safe Box Indel B presentano una solida struttura in acciaio, un sistema di chiusura motorizzato e la tastiera a filo con un display a led retro illuminato. Dopo 3 tentativi di apertura errati la cassaforte si blocca per 15 minuti; l'apertura di emergenza è comunque garantita da una chiave meccanica o da un master code.

DE

Die Indel B Safe Boxen haben eine solide Stahlstruktur, ein motorisiertes Schließsystem und eine bündige Tastatur mit einem hintergrundbeleuchteten LED-Display. Nach 3 falschen Öffnungsversuchen verriegelt sich der Tresor für 15 Minuten; die Notöffnung wird durch einen mechanischen Schlüssel oder einen Mastercode gewährleistet.



SAFE 10 BOX

- 200x310x200 mm (external)
- 175x300x135 mm (internal)
- 6,8 Kg
- Internal led light

SAFE 30 BOX

- 200x430x370 mm (external)
- 175x420x305 mm (internal)
- 11,7 Kg
- Internal led light

EN

Apart from comfort and refrigeration products, OFF keeps your belongings safe during the entire trip. A line of small safes to be installed in any vehicle.

IT

Oltre a comfort e refrigerazione la linea OFF garantisce la sicurezza dei tuoi oggetti più importanti durante il viaggio. Una linea di cassaforti dalle dimensioni contenute installabili all'interno di qualsiasi veicolo.

DE

Neben Komfort und Kühlung garantiert die OFF-Linie die Sicherheit Ihrer wichtigsten Gegenstände während der Fahrt. Eine Linie an Tresoren mit geringen Abmessungen, die in jedes Fahrzeug eingebaut werden können.





OFF is a brand of IndelB
©2023 - All right reserved

Creative Direction
studiogusto

Photographer
Gian Domenico Troiano
Francesco Bolis
Gabriele Vinci
Daniel Lutchner
Studio Metalli

Released on
August 2023

Design and specifications are subject to
modification without notice.

Indel B si riserva il diritto di modificare le
caratteristiche tecniche e di design senza
preavviso.

Indel B behält sich das Recht vor, Details in
Technik und Design ohne Vorankündigung zu
ändern.



indelB

Indel B S.p.A.
Via Sarsinate, 27
47866 - Sant'Agata Feltria, RN, Italy
info@indelb.com

off.indelb.com



Official distributor

MAJAR Group of Companies – Matzaridis Bros S.A.

I. Tsalouchidi 16 - 20, Business Center, 54248, Thessaloniki, Greece

Tel.: +30 2310 928 851

www.majar.gr - info@majar.gr

off.indelb.com